

MADE IN FRANCE
MANUFACTURER SINCE 1964



Car Body Welding System

Catalogue Carrosserie • Karosserie-Schweißtechnik Katalog
Catálogo de Soldadura para Carrocería

2016 C

www.gys.fr

SPOTTER • DENT PULLER • MIG • PLASMA • INDUCTION • LIFT • RIVETING • ACCESSORIES



A family firm since 1964

Une société familiale depuis 1964

Familienunternehmen seit 1964

Una empresa familiar desde 1964

Un'azienda familiare dal 1964

Een familiebedrijf sinds 1964

40 000 m²
400 000 sqf



550+

110





3



Partenaires • Partners • Asociados • Partner



A high tech R&D

R&D de pointe

Hochmodernes F&E

I+D de tecnología punta

R&S di punta

Hoogwaardige R&D



GYS Academy

Académie • Akademie
Academia • Accademia
Academy

Centre de formation agréé
Training centre dedicated to professionals
Trainingcenter für Profis
Centro de formación autorizado
Centro di formazione dedicato ai professionisti
Erkend opleidingscentrum

Formations agréées
Ref. 52 53 0068153



100% GYS

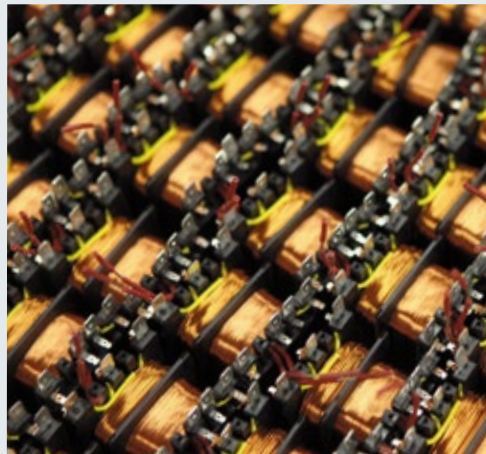



GYSPTOT 2600 Acier/Steel /Stahl 230V

2600 A

052208

OPTION SPOTTER BOX 2600
052277



GYSPTOT 2700 Acier/Steel /Stahl 230V

2600 A

055353

OPTION SPOTTER BOX 2700
053922

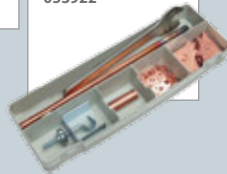

CHARIOT - TROLLEY



SERVANTES - WORKSTATIONS - P.14 - 21

		SYNERGIC			T						
					AUTOMATIC	MANUAL	SEPARATE CABLE GUN				
GYSPTOT 2600	▪	—	—	—	▪	—	—	1,8 m	Auto	—	2 m Option Spotter box 2600
GYSPTOT 2700	▪	—	▪	—	—	▪	—	1,8 m	—	▪	2 m Option Spotter box 2700
GYSPTOT 39.02	—	▪	▪	▪	▪	—	▪	2 m	Auto	—	4 m Included Spotter box
GYSPTOT PRO 230	—	▪	▪	▪	▪	▪	▪	2 m + 3 m	Auto	▪	8 m Included Spotter box (with studs)
GYSPTOT 39.04	—	▪	▪	▪	▪	—	▪	2 m	Auto	—	4 m Included Spotter box
GYSPTOT PRO 400	—	▪	▪	▪	▪	▪	▪	2 m + 3 m	Auto	▪	8 m Included Spotter box (with studs)



GYS POT 39.02	Acier/Steel /Stahl	230V	052215
GYS POT 39.04	Acier/Steel /Stahl	400V	052222
3 800 A			

GYS POT PRO 230	Acier/Steel /Stahl	230V	052178
GYS POT PRO 400	Acier/Steel /Stahl	400V	052185
2 3 800 A			
GUNS			

INCLUDED SPOTTER BOX STANDARD
053915
Details p.12



INCLUDED SPOTTER BOX PRO
050075
Details p.12

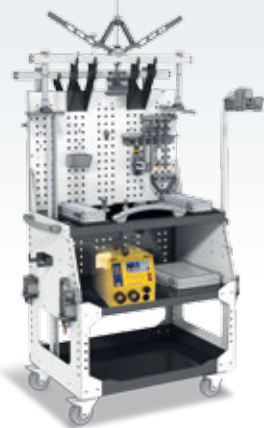

PATENTS REGISTERED NUMBERS
EUROPEAN TRADEMARK & DESIGN

PATENTS REGISTERED NUMBERS
001830845-0001
EUROPEAN TRADEMARK & DESIGN

STEEL DENT PULLING • DÉBOSSÉLAGE ACIER

MADE IN FRANCE 60974/1	CE NORM		I ₂ max A	U ₂ V		I _{RMS} A	kW				kg
GYS POT 2600	052208	230V	2600	5,4	16	1800	10	OK	—	20 x 32 x 18	14
GYS POT 2700	055353	230V	2600	5,4	16	1800	10	OK	—	20 x 32 x 18	14
GYS POT 39.02	052215	230V	3800	7,4	16	2800	20	OK	OK	22,5 x 36 x 23,5	23
GYS POT PRO 230	052178	230V	3800	7,4	16	2800	20	OK	OK	22,5 x 36 x 23,5	25,5
GYS POT 39.04	052222	400V, 2ph	3800	7,4	16	2800	20	OK	OK	22,5 x 36 x 23,5	23
GYS POT PRO 400	052185	400V, 2ph	3800	7,4	16	2800	20	OK	OK	22,5 x 36 x 23,5	25,5



GYS POT ALU PRO FV Alu **110 > 230V**
7500 A

021990

SYNERGIC CONTROL
Alu



PATENTS REGISTERED NUMBERS
EUROPEAN TRADEMARK & DESIGN

SYNERGIC CONTROL
Acier/Steel/Stahl



NEW
SOFT

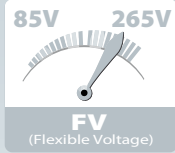

Process Alu

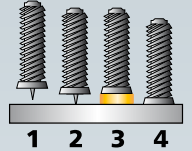

Alu Gun
Easy

PATENTS REGISTERED NUMBERS
002446450-0001
EUROPEAN TRADEMARK & DESIGN

+ INCLUDED
ALU BOX STANDARD
050020
Details p.12

Options (more p.18-19)

<p>Marteaux ALU - Alu hammers 020986</p>	<p>Alu Puller 051003</p>	<p>Inertia hammer 380 g 050051</p>	<p>Lampe à souder - Blow torch - Lötlampe 052741</p>	<p>Novacet + (Butane/ propane/ propylene) 380 ml/220 g 040441</p>	<p>Crayon marqueur thermique - Thermal marking pencil 121°C / 250°F 052765</p>	<p>Thermomètre infrarouge - Infrared Thermometer - Infrarot Thermometer -50 / +380°C -58 / +716°F 052994</p>
--	------------------------------	--	--	---	--	--



GYSPOT COMBI 230 E.PRO

021266

Acier/Steel /Stahl



Alu

230V

3800 A

7500 A



INCLUDED

- SPOTTER BOX PRO 050075
- + ALU BOX STANDARD 050020

Details 12-13



8m

2m Ø70mm²

3m Ø50mm²

3 GUNS INCLUDED

Acier/Steel/Stahl
Automatic

INCLUDED AUTOMATIC GUN
054035

049802

049482

PATENTS REGISTERED NUMBERS
00183045-0001
EUROPEAN TRADEMARK & DESIGN

Acier/Steel/Stahl
Manual

2m Ø70mm²

INCLUDED MANUAL GUN
052505

Alu
Automatic

INCLUDED AUTOMATIC ALU GUN
054066

3m Ø25mm²

 MADE IN FRANCE	 60974/1	 50/60 Hz	I ₂ A	SYNER-GIC			SEPARATE CABLE GUN	U ₂ V	 A	I _{RMS} A	kW	 OK	 OK	 cm	 kg
					Acier/Steel	Alu									
GYSPOT ALU PRO FV	021990	110>230V	7500	▪	—	AUTOMATIC	—	50 > 200	5	—	0,65	OK	OK	21 x 24 x 36	14
GYSPOT COMBI 230 E.PRO	021266	230V	3800 (steel) 7500 (alu)	▪	x2	AUTOMATIC + MANUAL	▪	7,4 (steel) 20 > 200 (alu)	16	2800 (steel)	20	OK	OK	45 x 43 x 29	49,7

MARTEAUX INERTIE - Inertia hammers - Ausziehhammer

<p>1,1 kg 049802</p> <p>COMPLETE 057272</p> <p>(x20) 052239</p> <p>(x1) 049482</p> <p>(x1) 054028 (x5) 050839</p>	<p>1,1 kg 041813</p> <p>Clous - Nails - Nägel</p> <p>Ø 2, M4 (x1) 049277</p> <p>Ø 2 (x100) 041561</p> <p>MIG/MAG nozzle for Nail welding 041523</p>	<p>1,7 kg 051201</p> <p>Rondelles - Washers - Ringe</p> <p>51 cm</p> <p>Ø 16, 8x16 (x1) 049574</p> <p>(x1) 051218</p> <p>8x16 (x100) 049444</p>	<p>Griffes - Gripping hook head - Ausbeulkit</p> <p>049819 2,5 kg</p> <p>COMPLETE KIT 051225</p> <p>(x1) (x50)</p> <p>(x1) (x25)</p>
---	--	--	--

LEVIER DE DÉBOSELAGE - Levelling lever - Zughebel

PATENTS REGISTERED NUMBERS
001652108-0002
EUROPEAN TRADEMARK & DESIGN

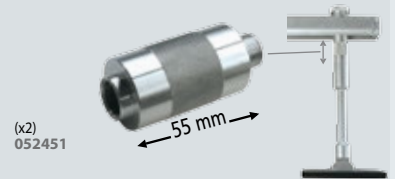

LEVIER DE DÉBOSELAGE - Levelling lever - Zughebel

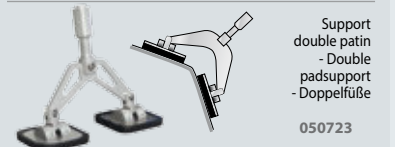
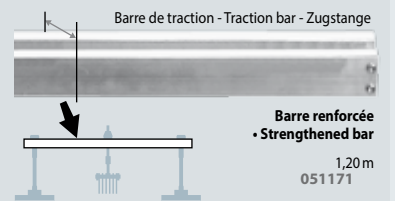
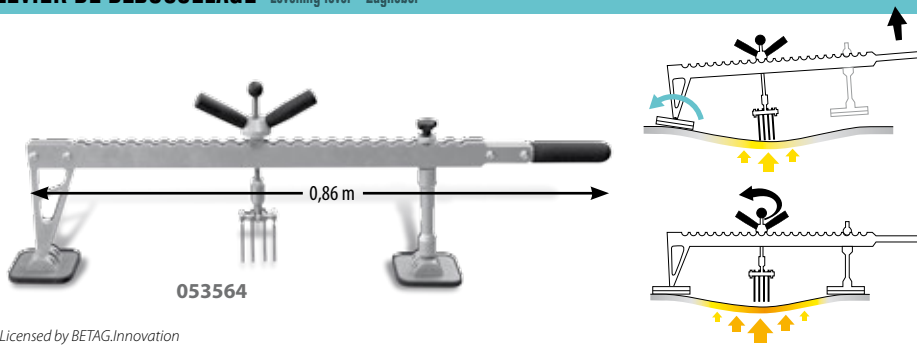

BARRE DE DÉBOSELAGE DOUBLE ACTION - Levelling bar double action - Zughebelbrücke



BARRE DE DÉBOSELAGE - Levelling bar - Zugbrücke

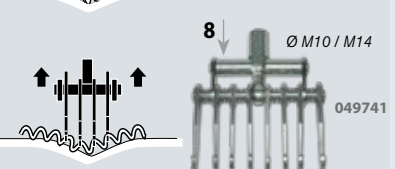
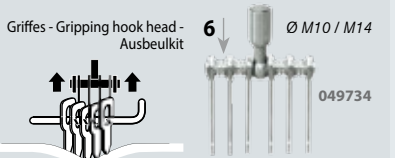
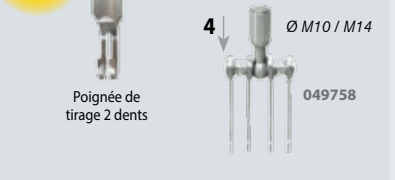
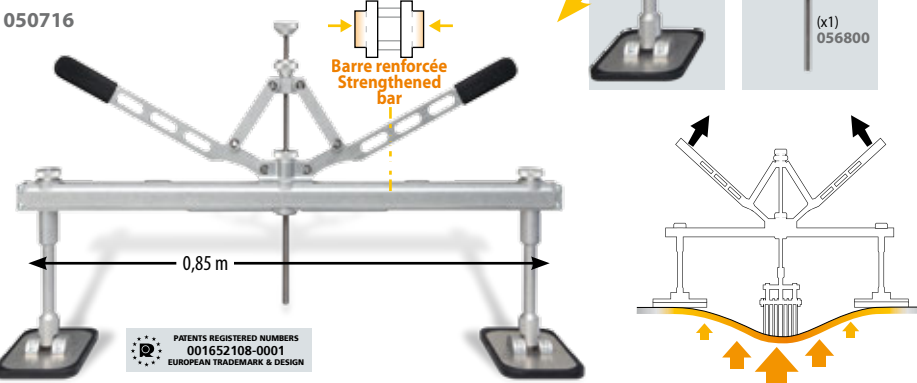

MANUSPOT

050679

for SPOT 600,
800, 1000, 1600
& Workstation

**NEW
2016**

PATENTS REGISTERED NUMBERS
001652108-0003
EUROPEAN TRADEMARK & DESIGN



MANULINER/GUN

056831

Adatper for gun included
(Ref. 052499)

**NEW
2016**

PATENTS REGISTERED NUMBERS
001652108-0003
EUROPEAN TRADEMARK & DESIGN



MANULINER

050471

PATENTS REGISTERED NUMBERS
001652108-0003
EUROPEAN TRADEMARK & DESIGN

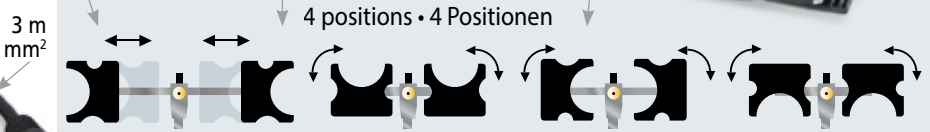

EASY TOOL CONNECTION



POIGNÉE DE TIRAGE MANUEL



EASY GUN
051317

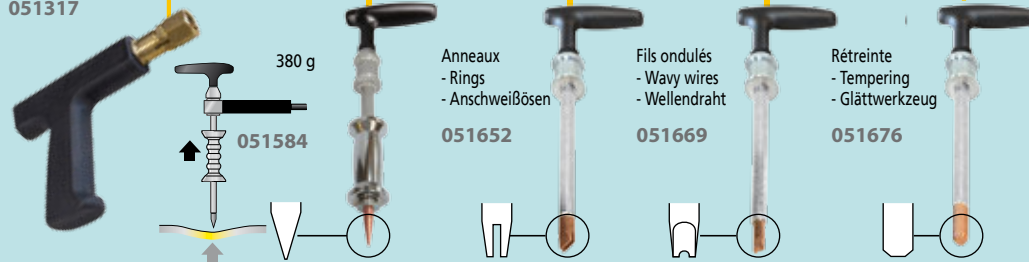

RINGMATIC

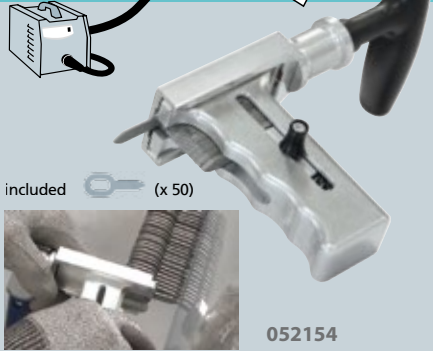

QUICK SPOT AIR GUN

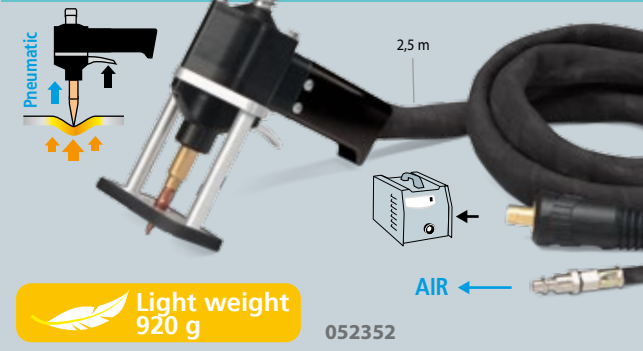

MANUSPOT / MANULINER / QUICK SPOT AIR GUN



MANUSPOT/MANULINER

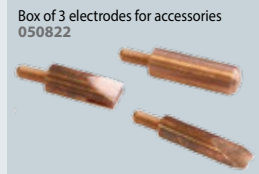

Graisse contact - Contact grease

050440



OPTION - ADAPTEUR POUR PISTOLET - Adapter for gun

For RINGMATIC & MANUSPOT 052499

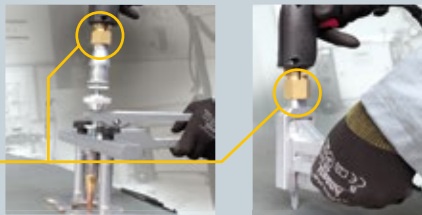

Adaptateur texas For QUICK SPOT AIR GUN



LASER LIGNE DROITE - Straight line laser

056770

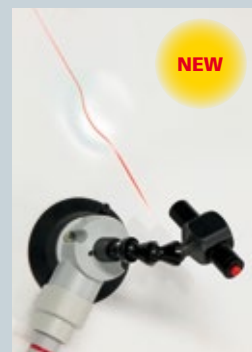



CONSOUMABLES ACIER - Steel consumables - Stahl-Verbrauchsmaterial



BEST SELLER

DENT BOX BAR
050037



SPOTTER BOX 2600
052277



SPOTTER BOX 2700
053922

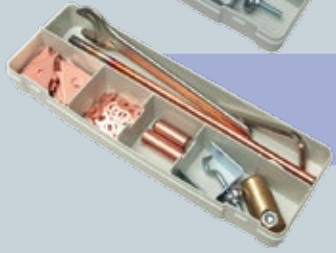

SPOTTER BOX STANDARD
053915

more

SQUARE LOCK NUT - M8 (x100) 050303

MAGNETIC POSITIONER (x1) 049772

MAGNETIC EARTH (x1) 049666

ELECTRODE FOR MAGNETIC EARTH (x1) 050013

THREADED ROD FOR MAGNETIC EARTH (x5) 055438

SINGLE HOOK (x1) 051218

ELECTRODE WHEEL ø16 (x1) 050310

EARTH PLATE (x1) 052529

ELECTRODE FOR NAILS Ø2, M4 (x1) 049277

NAIL Ø2 (x100) 041561

x 25		WAVY WIRES x 50 049727	x 25
x 50		STRAIGHT PULLING RINGS x100 050648	x 50
x 1		LIFTING ROD x3 050792	x 1
x 1		ELECTRODE FOR WAVY WIRES x 1 049789	x 1
x 1		ELECTRODE FOR RINGS x 1 050655	x 1

x 20		STAR WITH COPPER COATING x 20 052239	Dent Box Easy x 10
x 1		ELECTRODE FOR RINGS ø16 - 8 x 16 x 1 049574	Spotter Box Pro x 20
x 50		CENTERING RINGS ø 8 x 16 x 100 049444	x 50
x 1		FLAT KEY N°27 x 1 049673	x 1
x 1		EARTH HOOK x 1 056718	x 1
x 1		CARBON HEATING ELECTRODE x 5 049468	x 1
x 1		STAR-CHUCK FOR INERTIA HAMMER x 1 049482	x 1
x 1		HEXAGON KEY	x 1
x 1		EARTH PLATE	x 1
x 1		ELECTRODE WARMING POINT - ø 16 x 1 049567	x 1

	ELECTRODE FOR AUTO-THREADED RIVETS ø 5 - M5, M6 x 1 049598	x 1
	ELECTRODE FOR RIVETS ø 16, 3 x 4,50 x 1 049604	x 1
	THREADED STUDS ø 5 x 18 x 100 049383	x 50
	THREADED STUDS ø 5 x 18 x 100 049420	x 50
	RIVETS ø 4 x 16 x 100 049413	x 50
	RIVETS - ø 3 x 3,25 x 100 049345	x 100
	RIVETS - ø 3 x 4,50 x 100 049352	x 100

MANDRINS POUR PISTOLETS - Mandrels for gun - Pistole mit Anschlussstücke, Zubehor

Pour débosseleurs - for dent pullers



Pour soudeuses par point - for spot welding machines

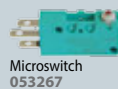

MASSE PISTOLET ACIER - Steel gun earth adapter - Masse für





CONSUMMABLES ALU - Alu consumables - Alu-Verbrauchsmaterial

DENT BOX EASY
053632

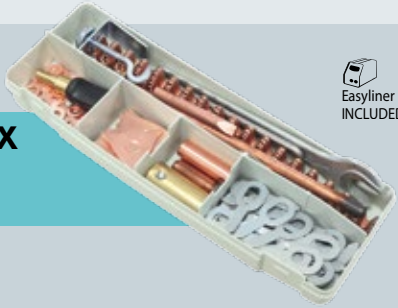

Easyliner INCLUDED

SPOTTER BOX PRO
050075



Pro 230
Pro 400
Combi 230 INCLUDED

BEST SELLER

DENT BOX CONSUMABLES
051515

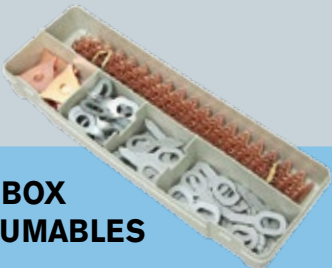

x 25		WAVY WIRES x 50 049727
x 20		STARS WITH COPPERCOATING x 20 052239
x 50		STRAIGHT PULLING RINGS x 100 050648
x 25		TWISTED PULLING RINGS x 50 050631



ALU BOX LIGHT (Ø4)
051522

x 200		ALU MAGNESIUM SCREWS 12 mm - Ø 4 - M4 x 200 050273 x 1000 050129
-------	--	---



ALU BOX STANDARD (Ø4)
050020

x 200		ALU SILICON SCREWS 12 mm - Ø 4 - M4 x 200 050280 x 1000 050136
-------	--	---

x 5		SCREWABLE RINGS Ø 4 x 5 050297
-----	--	---

x 1		LIFTING ROD x 3 050792
-----	--	------------------------------

Gyspot Alu
Combi 230
INCLUDED

ALU BOX Ø5 & 6
048195



	MANDREL FOR ALU GUN	Ø 5	048157	x 1
		Ø 6	048164	x 1
	ALU MAGNESIUM SCREWS 12 mm	Ø 5	048140	x 100
		Ø 6	048133	x 100
	ALU SILICON SCREWS 12 mm	Ø 5	048126	x 100
		Ø 6	048003	x 100
	SCREWABLE RINGS	Ø 5	052635	x 5
		Ø 6	052628	x 5

more (Ø4)

	MANDREL FOR ALU GUN - Ø 4 (x2) 049000		x1 050945
	TENSION MANDREL FOR M4 (x1) 050327		x1 050938

Stahl Pistole



051997

AFFÛTEUR PNEUMATIQUE D'ANNEAUX - Pneumatic Bit Cutter



056763

Made in P.R.C.

NEW 2016

pour anneaux de tirage droits ou torsadés - for straight or twisted pulling rings





MADE IN FRANCE

Acier/Steel/Stahl	
EASYLINER	
3 800A 053618	2 600A 055445
GYSPOT 39.02	GYSPOT 2700
Trolley SPOT 1000 053540	Dent box easy 053632 (p.13)
 0,86 m Levelling bar double action 053564 (p.10)	
ALL IN 1 BOX	

Spot 600
053533



Spot 800
051331



Spot 1000
053540





Acier/Steel/Stahl

PROLINER

39.02 (230V) 035775	39.04 (400V) 035782	PRO 230 (230V) 035799	PRO 400 (400V) 035805
-------------------------------	-------------------------------	---------------------------------	---------------------------------



GYSPT 39.02



GYSPT 39.04



GYSPT PRO 230



GYSPT PRO 400



Trolley SPOT 800
051331

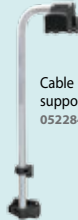

Cable support
052284

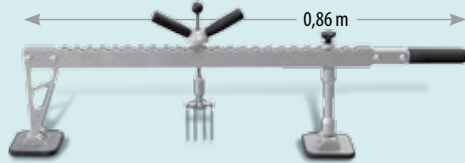

Levelling bar double action
053564 (p.10)



Dent box bar
050037 (p.12)



MADE IN FRANCE

OPTIONS



Manuliner
050471



Ringmatic
052154



QUICK SPOT AIR GUN
052352

Spot 1600

051348

Workstation

050747

Dentstation PRO

056848



NEW
10-2016



Acier/Steel/Stahl

SPEEDLINER

39.02 (230 V)
035010

39.04 (400 V)
035027

SPEEDLINER

PRO 230 (230 V)
036017

PRO 400 (400 V)
036024

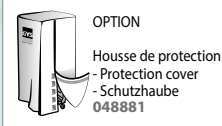
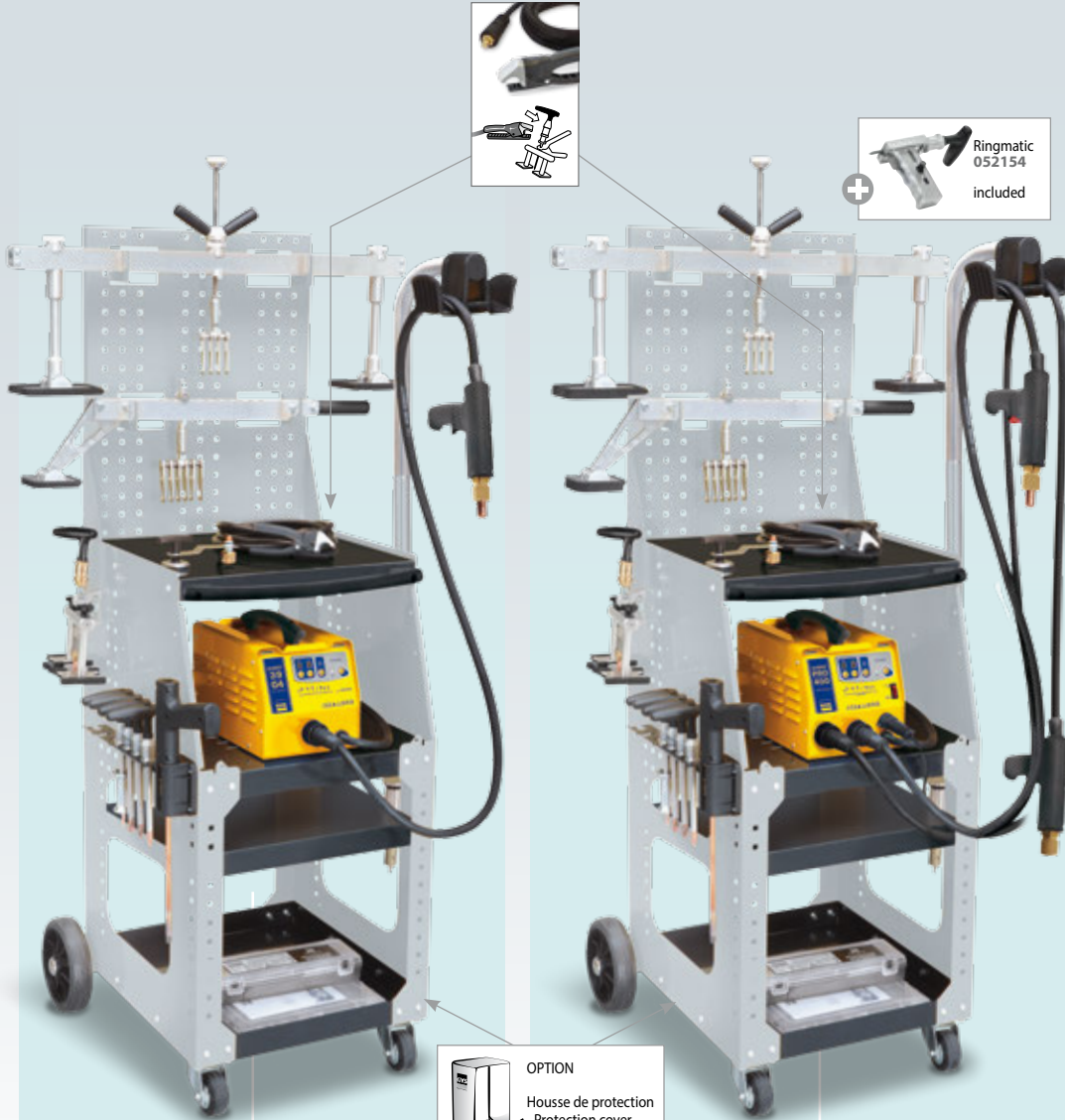

GYSPT 39.02



GYSPT 39.04



GYSPT PRO
230



GYSPT PRO
400



Trolley SPOT 1600 051348



Manuspot 050679 (p.11)



Levelling bar 050693 (p.10)



Levelling lever 050686 (p.10)



052451 (p.10)



4 gripping multihook head
049758 (p.10)



6 gripping multihook head
049734 (p.8)



3 lifting rods 050792 (p.12)



Dent box consumables
051515 (p.13)



Magnetic earth 049666 (p.12)

SPEEDLINER
(without generator)
035058



MADE IN FRANCE



Acier/Steel/Stahl

GYSLINER

39.02 (230 V)
035096

39.04 (400 V)
035102

GYSLINER

PRO 230 (230 V)
036031

PRO 400 (400 V)
036048

Workstation 050747



Fixing kit 051362



Manuspot 050679 (p.11)



Levelling bar 050693 (p.10)



Lifting bar 050716 (p.10)



Double pads support 050723 (p.10)



Levelling lever 050686 (p.10)



Strengthened bar 1,2m 051171 (p.10)



052451 (p.10)



4 gripping multihook head 049758 (p.10)



6 gripping multihook head 049734 (p.8)



8 gripping multihook head 049741 (p.10)



3 lifting rods 050792 (p.12)



Dent box consumables 051515 (p.13)



Magnetic earth 049666 (p.12)

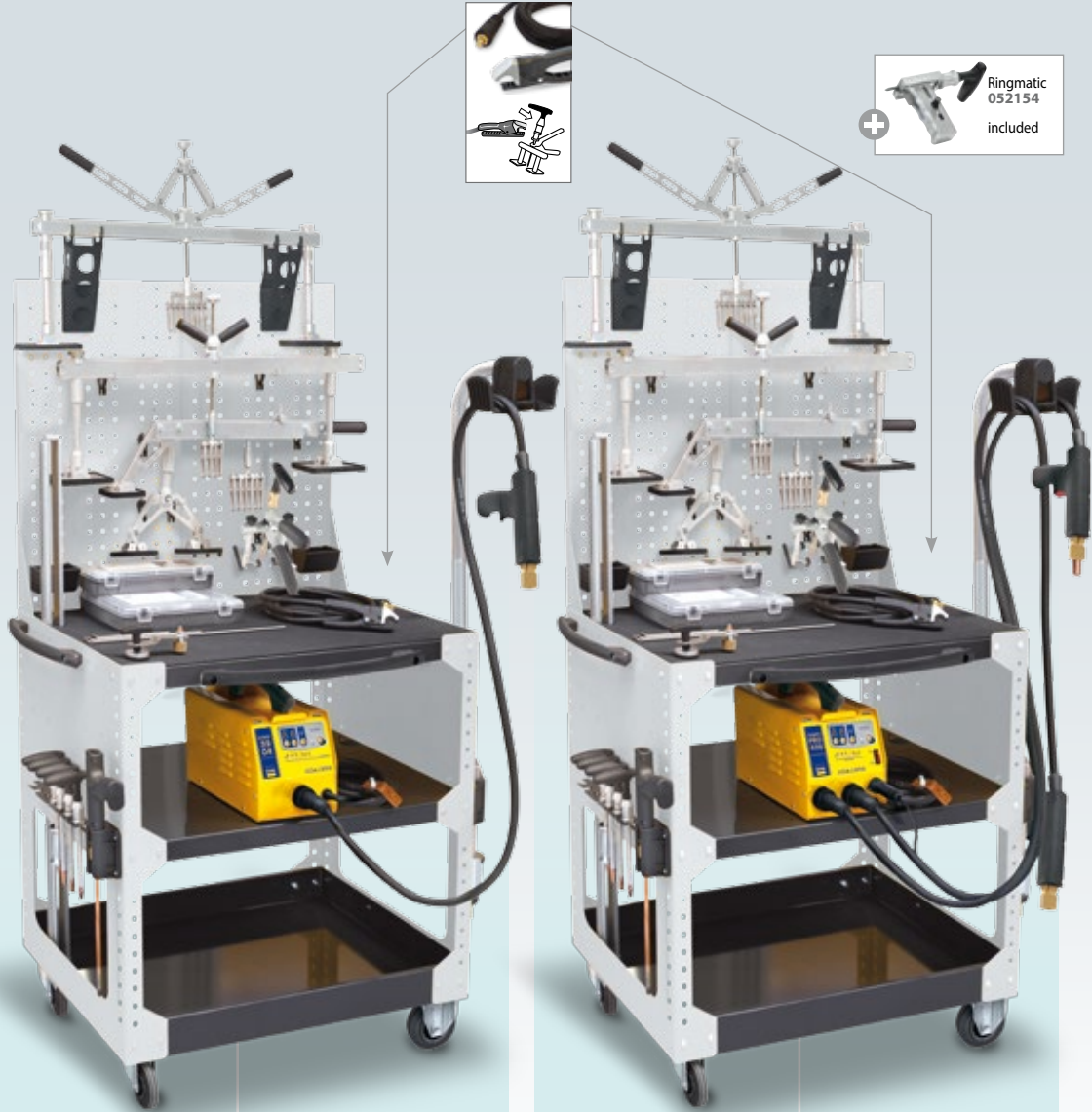

GYSLOT 39.02



GYSLOT 39.04



GYSLOT PRO 230



GYSLOT PRO 400



GYSLINER
(without generator)
035133

MARTEAUX ALU
- Alu hammers

020986



ALU PULLER
051003



050921

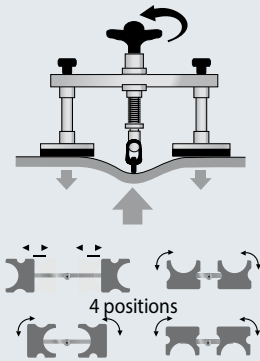

050945

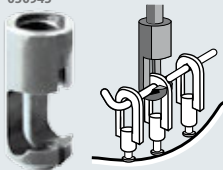

050938

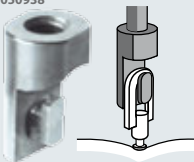

Housse de protection
- Protection cover
- Schutzhaube
048881



MARTEAU À INERTIE
- Inertia hammer
- Ausziehhammer



380 g
050051

LAMPE À SOUDER - Blow torch - Lötlampe



052741



HIGH QUALITY

Novacet +
(Butane/propane/
propylene)
380 ml/220 g
040441



Alu

**PROLINER
ALU PRO FV**

035836

MADE IN FRANCE



GYSPT ALU PRO FV



Trolley SPOT 800 051331



Alu puller 051003



Cable support 052284



GYSPT ALU PRO FV



Trolley SPOT 1600 051348



Alu puller 051003



Fixing kit 051362

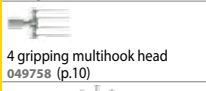

4 gripping multihook head 049758 (p.10)



Levelling bar 050693 (p.10)



Alu Box Ø5 & 6 048195 (p.13)



Alu hammers 020986

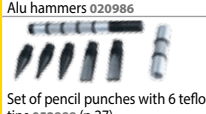

Set of pencil punches with 6 teflon tips 052888 (p.27)



Mini disc sander 051829 (p.64)

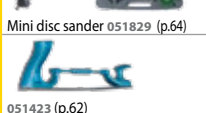

051423 (p.62)



Infrared Thermometer 052994

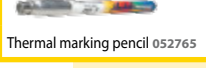

Thermal marking pencil 052765

Alu

SPEEDLINER ALU PRO FV

036055



MADE IN FRANCE

BROSSES - Brushes
- Bürsten - Brosses
- Cepillos

Inox - Stainless - Edelstahl
044258

CRAYON MARQUEUR THERMIQUE
- Thermal marking pencil

052765

121°C / 250°F

THERMOMÈTRE INFRAROUGE
- Infrared Thermometer
- Infrarot Thermometer

052994

-50 / +380°C
-58 / +716°F

SPRAY REFROIDISSEUR
- Freezer spray

-50 °C
400 ml

(x 12)
048898

GEL BARRIERE THERMIQUE
- Heat barrier spray

054325



Acier/Steel/Stahl **+** Alu

**SPEEDLINER
COMBI 230 E.PRO**

036062

**Complete
solution**

MADE IN FRANCE



GYS SPOT COMBI 230 E.PRO	Trolley SPOT 1600 051348
Manuspot 050679 (p.11)	
4 gripping multihook head 049758 (p.10)	6 gripping multihook head 049734 (p.10)
Levelling bar 050693 (p.10)	Levelling lever 050686 (p.10)
Ringmatic (p.11) 052154	
3 lifting rods 050792 (p.12)	
052451 (p.10)	Magnetic earth 049666 (p.12)
Dent box consumables 051515 (p.13)	
Spotter box pro 050075 (p.13)	



+	
	Alu puller 051003 (p.18)
	Alu box standard 050020 (p.13)
	Cable support 052284





GYSPOT COMBI 230 E.PRO Workstation 050747	
Manuspot 050679 (p.10)	
Fixing kit 051362	
4 gripping multihook head 049758 (p.10)	6 gripping multihook head 049734 (p.10)
8 gripping multihook head 049741 (p.10)	Double pads support 050723 (p.10)
Levelling bar 050693 (p.10)	Levelling lever 050686 (p.10)
Ringmatic (p.10) 052154	Lifting bar 050716 (p.10)
Strengthened bar 1,2m 051171 (p.10)	
3 lifting rods 050792 (p.12)	
052451 (p.10)	Magnetic earth 049666 (p.12)
Dent box consumables 051515 (p.13)	
Spotter box pro 050075 (p.13)	



Expert solution

Acier/Steel/Stahl **+** Alu
GYSLINER COMBI 230 E.PRO
036079



+

Alu puller
051003
(p.18)

Alu box standard
050020
(p.13)

Cable support
052284

OPTION

QUICK SPOT AIR GUN
(p.11)
052352

ALU / STEEL WORKSTATIONS • SERVANTES ALU / ACIER



MADE IN FRANCE

Acier/Steel/Stahl

DENTSTATION

PRO 230 (230V)

PRO 400 (400V)

036420

036437









NEW
10-2016







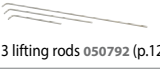



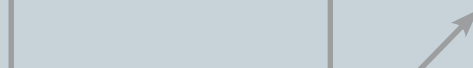



GYSPOT PRO 230



GYSPOT PRO 400

-  Dentstation Pro 056848
-  Manuspot 050679 (p.11)
-  Ringmatic 052154 (p.11)
-  Manual pulling handle 057289 (p.11)
-  Levelling bar 050693 (p.10)
-  Lifting bar 050716 (p.10)
-  Double pads support 050723 (p.10)
-  Levelling lever 050686 (p.10)
-  Strengthened bar 1,2m 051171 (p.10)
-  052451 (p.10)
-  4 gripping multihook head 049758 (p.10)
-  6 gripping multihook head 049734 (p.8)
-  8 gripping multihook head 049741 (p.10)
-  3 lifting rods 050792 (p.12)
-  Dent box consumables 051515 (p.13)
-  Magnetic earth 049666 (p.12)



- 
Dentstation Pro 056848
- 
Manuspot 050679 (p.11)
- 
Ringmatic 052154 (p.11)
- 
Manual pulling handle 057289 (p.11)
- 
Levelling bar 050693 (p.10)
- 
Lifting bar 050716 (p.10)
- 
Double pads support 050723 (p.10)
- 
Levelling lever 050686 (p.10)
- 
Strengthened bar 1,2m 051171 (p.10)
- 
052451 (p.10)
- 
4 gripping multihook head 049758 (p.10)
- 
6 gripping multihook head 049734 (p.8)
- 
8 gripping multihook head 049741 (p.10)
- 
3 lifting rods 050792 (p.12)
- 
Dent box consumables 051515 (p.13)
- 
Magnetic earth 049666 (p.12)



MADE IN FRANCE

Acier/Steel/Stahl + Alu

DENTSTATION COMBI 230 E.PRO

036444

NEW
10-2016

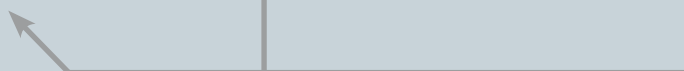
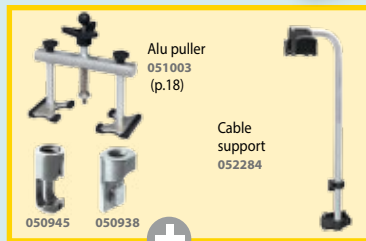
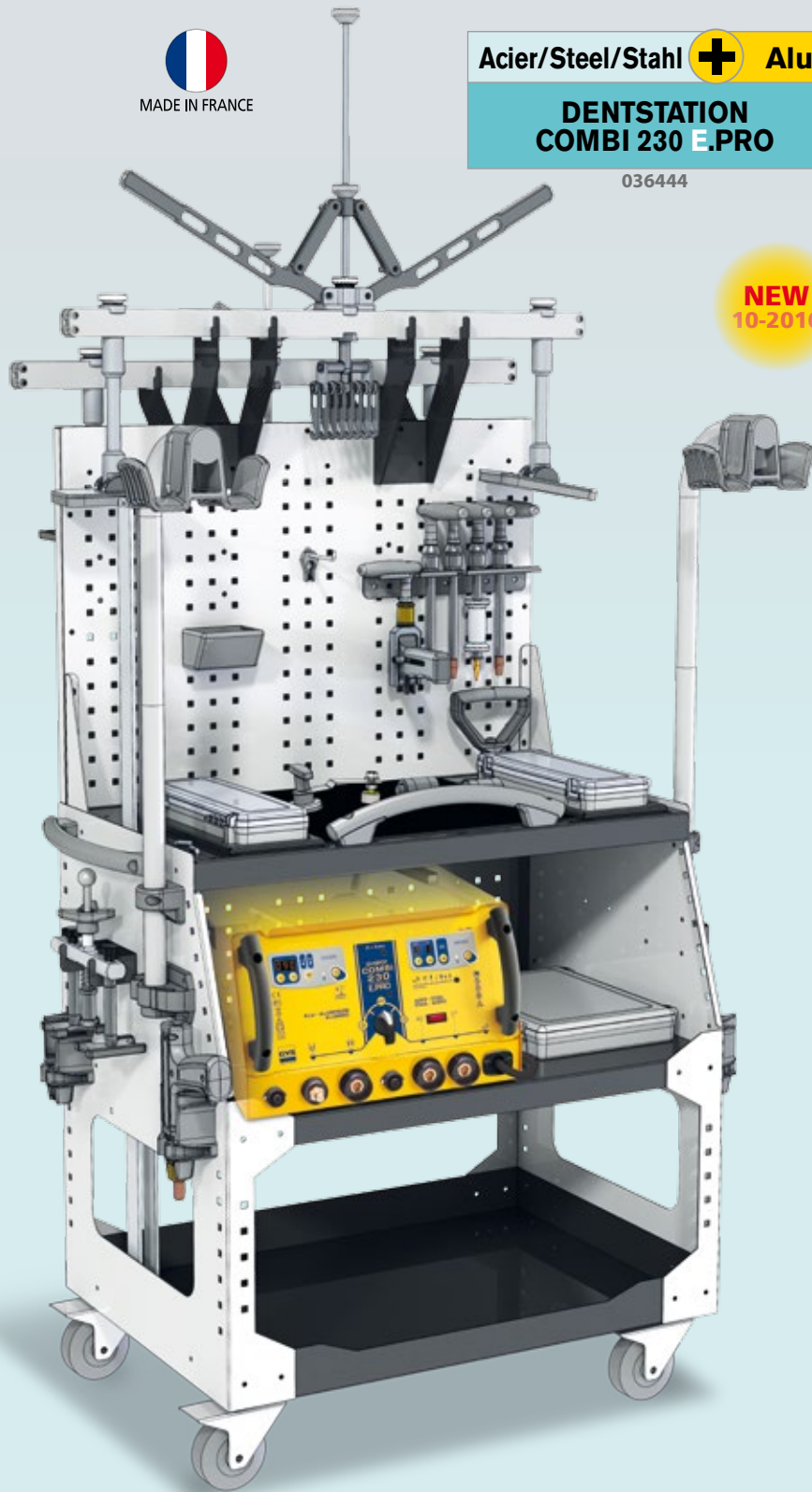

**ÉQUERRE DE TIRAGE - DRAW ALIGNER
- SCHNELLAUSBEUL-RICHTAUSLEGER**

052475

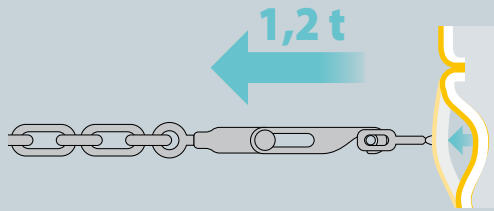

NEW DESIGN

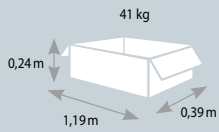
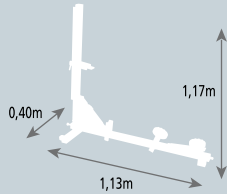

MADE IN FRANCE

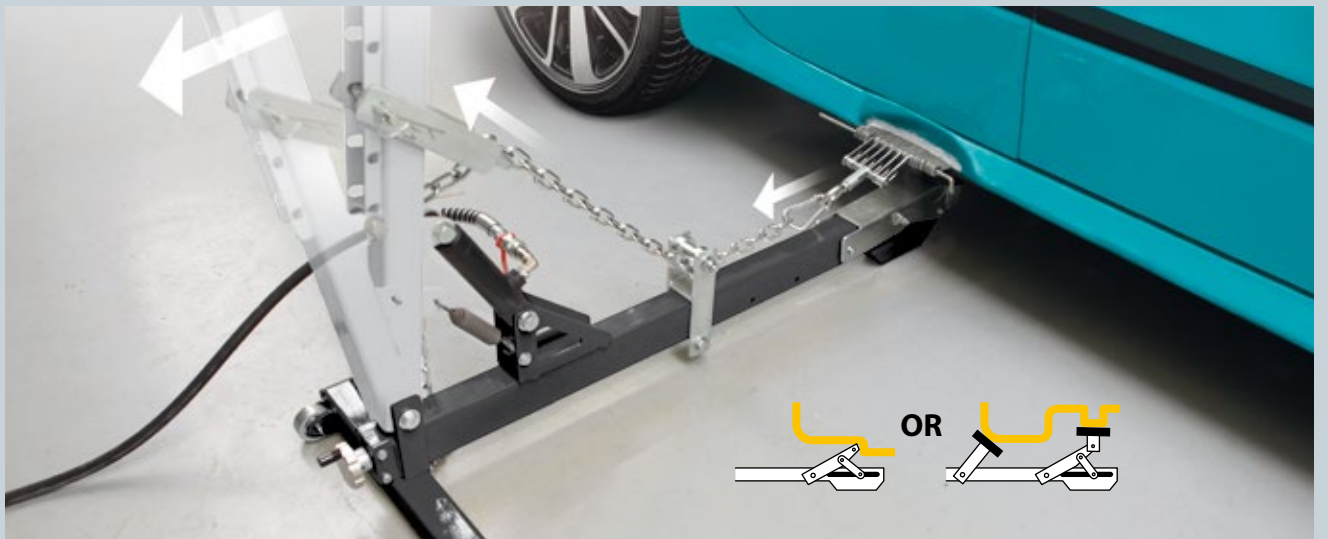

OPTION
Bras de bas de caisse
- Rocker panel arms
for draw aligner
- Abstütztraverse
für Richtausleger

052581

7 kg

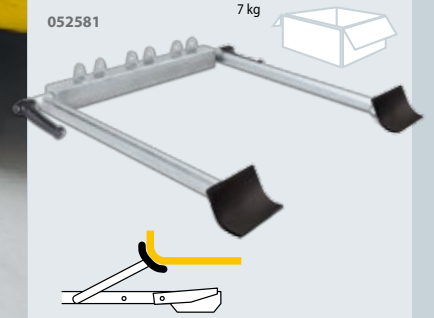

UNIVERSAL

SYSTÈME DE TIRAGE SMART PULLER SILVER - SMART PULLER SILVER PULLING SYSTEM - SCHNELLAUSBEUL-RICHTAUSLEGER SMART PULLER SILVER

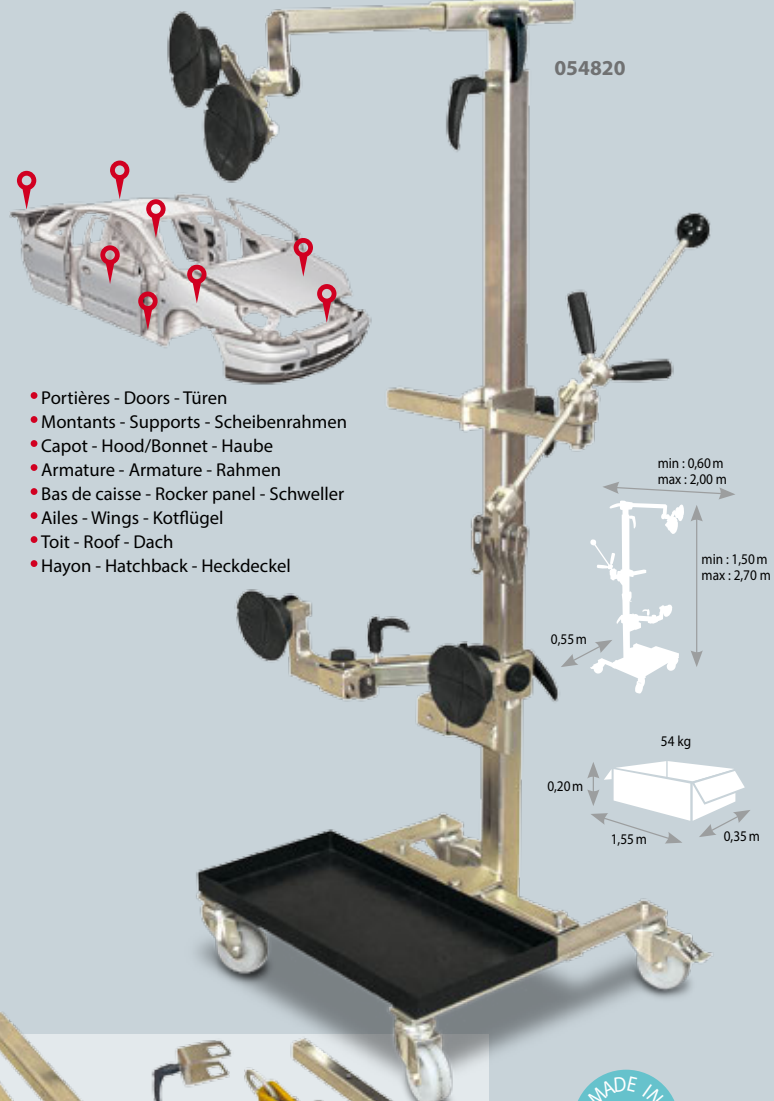
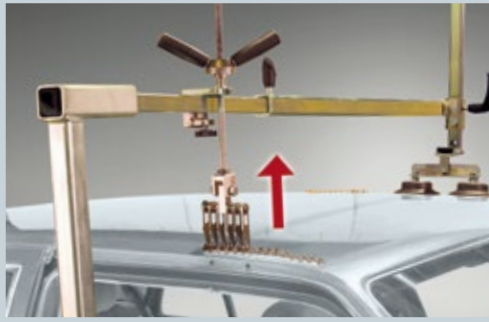

- Portières - Doors - Türen
- Montants - Supports - Scheibenrahmen
- Capot - Hood/Bonnet - Haube
- Armature - Armature - Rahmen
- Bas de caisse - Rocker panel - Schweller
- Ailes - Wings - Kotflügel
- Toit - Roof - Dach
- Hayon - Hatchback - Heckdeckel



Autorobot®

Spreading / Estensione

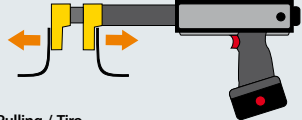

Pressing / Compressione

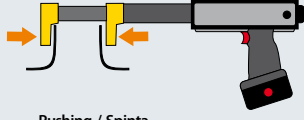

Pulling / Tiro



Pushing / Spinta

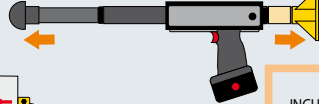

Applications / Applicazioni

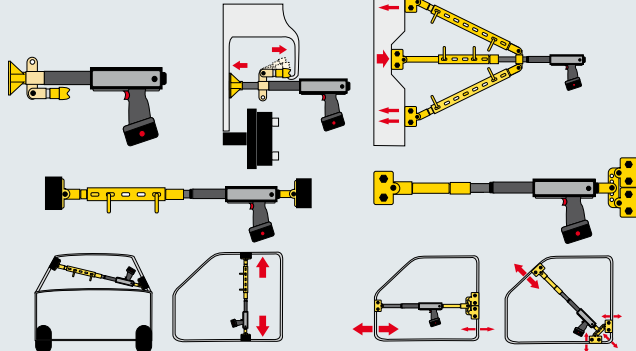

ELECTRO POWER



with accessories:
057425

PULLING POWER: 5 Ton.
PUSHING POWER: 5 Ton.
PISTON STROKE: 130 mm

NEW
09-2016



Standard kit : 425x620x210 mm
Standard kit Total weight: 18 Kg
057401

Accessories kit : 425x620x150 mm
Accessories kit Total weight: 20 Kg
057418

SATELLITE INTELLIGENT - Smart Satellite - Satellite Komplett-Kit

The best from **Autorobot**
 www.autorobot.com/pdf/7148_ENG.pdf
 MADE IN FINLAND



PACK SATELLITE

= 1 + 2 + 3 + 4 + 5 + 6

=
 052727

1 SATELLITE
 - Satellite - Satellite Basisbügel-Set



052710



360°

2 KIT MAC PHERSON (A)
 - Mac Pherson Kit - Befestigungskit-Federbein (McPherson)



052703



3 BARRE POUR TIRER/POUSSER
 - Push/Pull Bar
 - Zug/Druck-Stangenset



052673



4 SATELLITE (B)
 - Bügelverlängerung

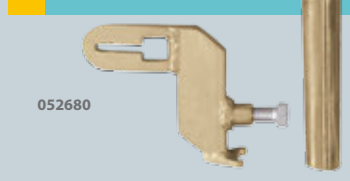

052680



5 SANGLE DE SÉCURITÉ
 - Safety Strap - Sicherungsgurt



044036



6 DOUBLE PINCE SATELLITE (C)
 - Double Clamp Satellite
 - Satellite Doppelklemme



052697



PINCE DE TIRAGE MULTI-USAGE
 - Versatile pulling clamp
 - Multifunktions-Zugklemme



053571



Autorobot

KIT MARTEAU INERTIE - Inertia hammer kit - Ausziehhammer kit

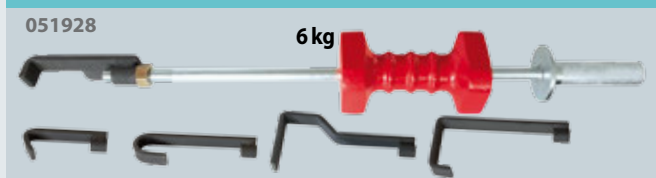

051928

6 kg

COFFRET VÉRIN HYDRAULIQUE - Hydraulic cylinder kit - Hydraulischer Drucksatz

MADE IN P.R.C.



4T
 052345



10T
 052338

OUTILS DE TIRAGE - Frame Straightening - Ziehwerkzeuge

Kit crochet de tirage « boomerang »
- Boomerang pulling hook set
- Zughaken Set «Boomerang»

052659

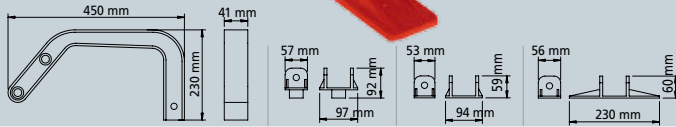

Pince de tirage à angle droit
- Right angle pull clamp - Zugklemme 90° Winkel

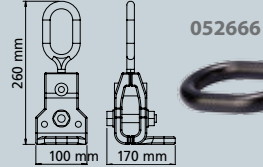

052666



Pince de tirage à blocage automatique
Self-locking pull clamp - Selbstklemmende Zugklemme

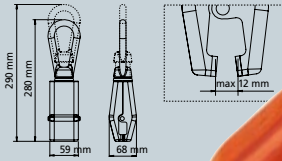

052642

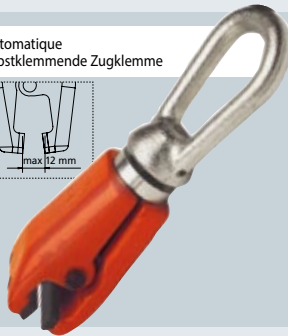

Mini pince de tirage a blocage manuel - Manual-locking pull clamp - Mini Klemme von Auflage in Handblockieren

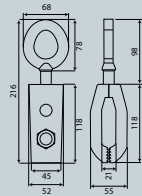

056855



BARRE D'ANCRAGE - Anchor bar - Türspanner

MADE IN TAIWAN

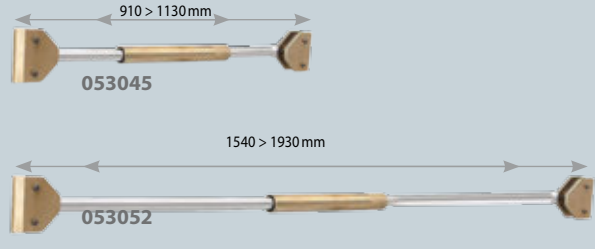

MESURES - Measuring tools - Vermessung

GYSMETER, Electronic measurements

052093



Light weight measuring arm with an easy to read digital display



Measuring report

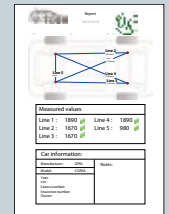

400 > 2650 mm

BODYMETER, Mechanical Measurements

052130



RAIL SAVER

052970

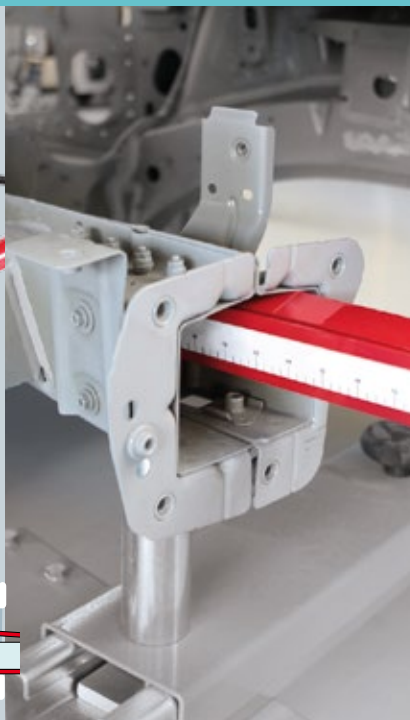
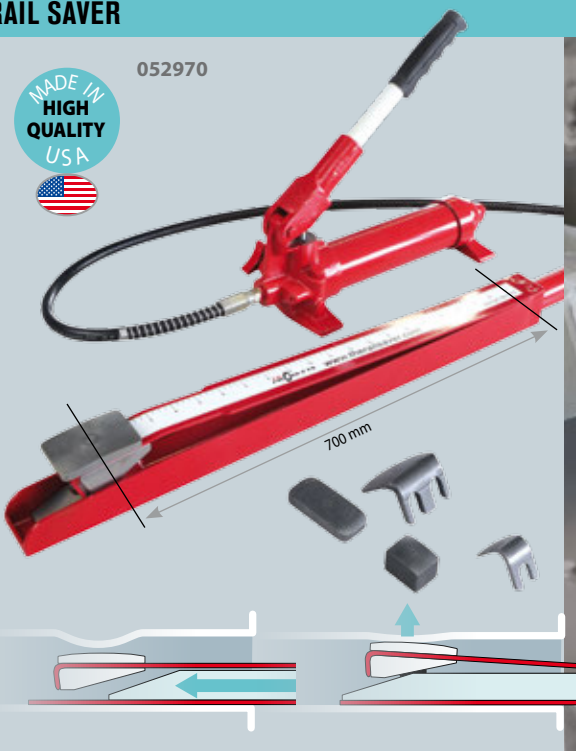



Débosselage rapide et sans peinture - Fast paintless dent pulling - Lackschadenfreies Ausbeulen

**GYS DUCTION AUTO
DENT REPAIR**
054981

GYS DUCTION AUTO

 +
Dent pulling Inductor
Débosselage - Dent pulling -
Ausbeul Induktor

OPTION

 Spray
refroidisseur
- Freezer spray

 -50 °C
400 ml

 (x 12)
048898

**GYS DUCTION
AUTO (Steel / Acier)**

50 Hz	A	W	kHz	PFC	FV	Liquid Cooling	Cable L (m)	Inductor	cm	kg
110V, 1~ 230V, 1~	25 16	2 400	35+120	■	■	—	2	2,5	22x36 x 27	7,2

KIT MAGNÉTIQUE DE DÉBOSELAGE SANS PEINTURE
- Paintless Dent Repair magnetic kit - Magnetisches Ausbeul-Kit

053168

EXELTOOLS

LAMPES DE DÉBOSELAGE - Paintless Dent Repair lamps
- Ausbeullampe

**NEW
2016**

Made in Taiwan

ULTRA LIGHT CARBON X40 PW
053175

EXELTOOLS



GLUE PULLER (Acier/Alu • Steel/Alu)

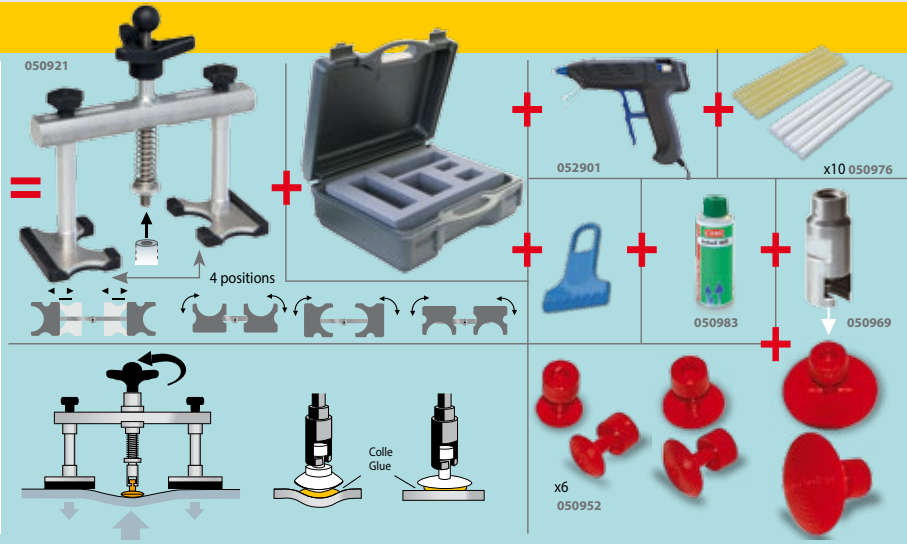

Glue Puller
050990

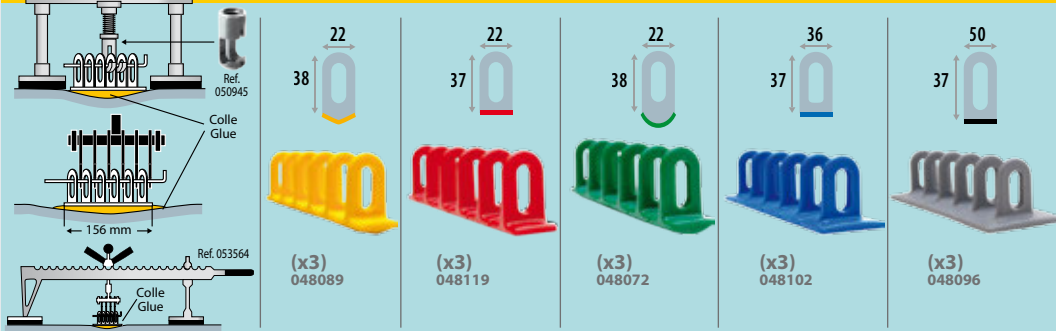

BARRETTES ANNEAUX PLASTIQUE - Plastic Multipads Ösen-Klebe pads



OPTIONS



KIT DÉBOSSelage SANS PEINTURE - Dent Pulling Kit (paintless) - Dellenausbeulhebel-Set



KIT DE 6 COINS DE FRAPPE - Set of 6 pencil punches - Beulenstemmer-Satz mit 6 Tefloneinsätzen



MARTEAU INERTIE PNEUMATIQUE - Pneumatic inertia hammer - Unterdruck-Schlaghammer

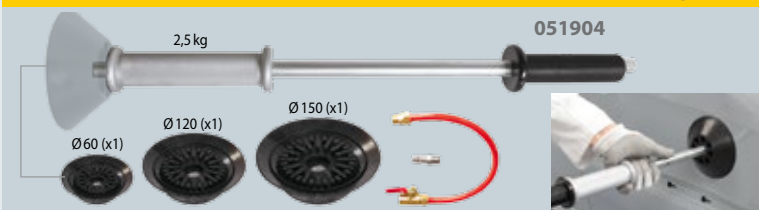

KIT COUSSINS GONFLABLES - Air Cushion Kit - Luftpolster-Spreizkissen-Satz



MARTEAU À INERTIE À VENTOUSES (POMPAGE MANUEL) - PUMP AIR SUCTION SLIDE HAMMER - Man. Unterdruck-Schlaghammer





052864



MADE IN FRANCE

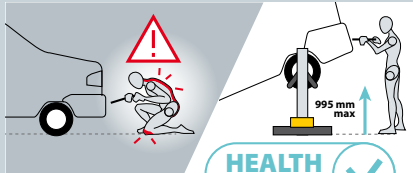
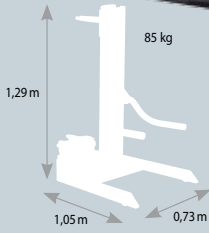
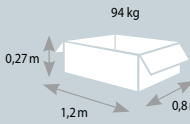

HEALTH CARE

Haute stabilité - High stability

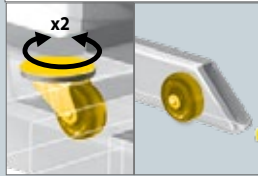
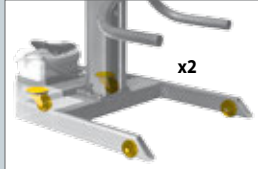

OPTION
Outil de levage pour bas de caisse
- Rocker panel lifting tool
- Auflage für Seitenschweller



Included 300 bar
053588



CHARIOT DE MANUTENTION PRISE SOUS ROUE

- Wheel truck - Kfz-Montagelift, fahrbar

Jacks hydrauliques de manutention
- Hydraulic positioning jacks



30,5 cm max



(x2)
053243

Made in P.R.C

TABOURETS DE MANUTENTION

- Wheel trolleys - Radhocker



MADE IN FRANCE

26 cm max

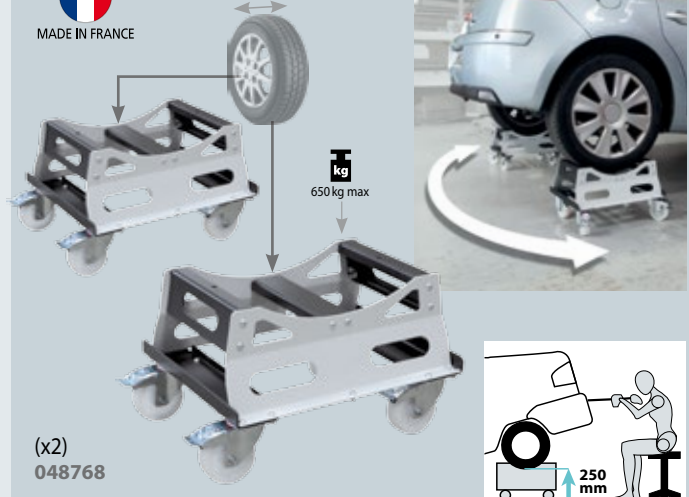

(x2)
048768

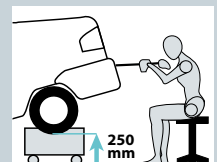

SPOT LIFT PRO

053557



MADE IN FRANCE

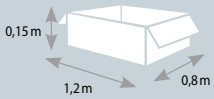
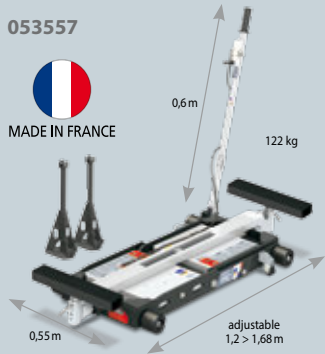

60 cm max
14 cm min



NEW

OPTION

Réhausseur pour 4x4 et utilitaires
- Height adjuster for 4x4 & utility vehicles
- Erhöhung f. 4x4 und Leicht-LKW



NEW

OPTION
Rampes - Ramps
700 x 200
x 80mm

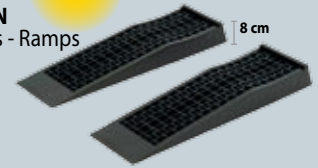

x2
056787

SPOT LIFT PRO MOB

055896



MADE IN FRANCE

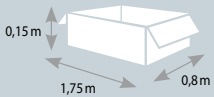
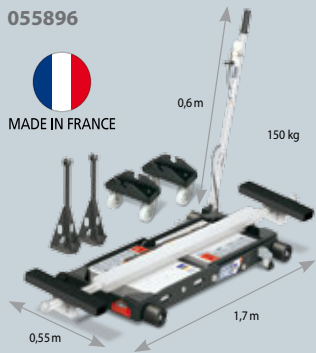

NEW
11- 2016



60 cm max
14 cm (min)



360°

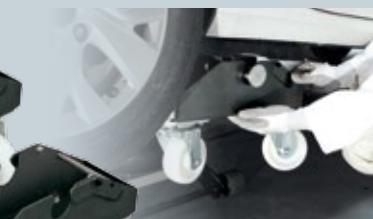



Facteurs d'évolution :
 • Challenge CO2 = faible poids
 • Crash test = ★★★★★
 • Anti corrosion = nouveaux revêtements
 • Esthétique et visibilité plus sophistiquées.



Evolution factors :
 • CO2 Challenge = low weight
 • Crash test = ★★★★★
 • Anti-corrosion = new coatings
 • Improved aesthetics and demand for better occupant visibility.



Entwicklungsfaktoren :
 • CO2 Challenge = geringes Gewicht
 • Crash-Test = ★★★★★
 • Anti-Korrosion = neue Beschichtung
 • Modernes Technik-Design.



Factores de evolución :
 • Challenge CO2 = peso débil
 • Ensayo de choque = ★★★★★
 • Anti-corrosión = nuevos revestimientos
 • Diseño y visibilidad mas sofisticadas

2004

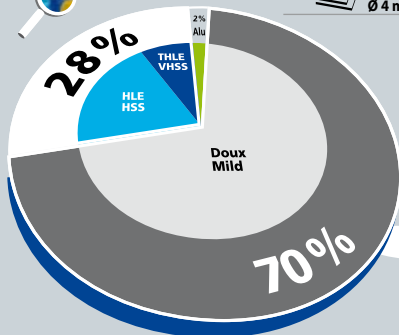

OLD SOLUTIONS

Traditional machines
 180 daN max
 6 500 A max
 X clamps
 Ø 4 mm max

2016

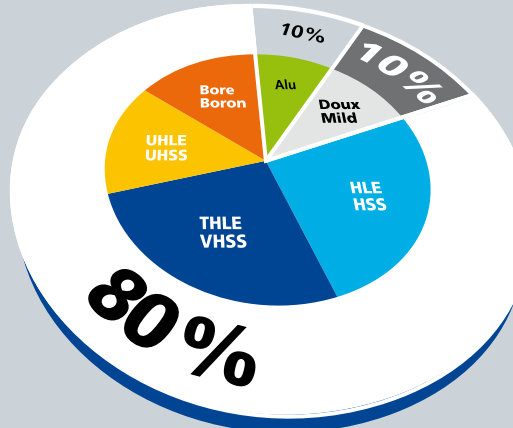

GYS SOLUTIONS

INVERTER Technology
 550 daN max
 14 500 A max
 X & C clamps
 Liquid cooled system
 Ø 10 mm

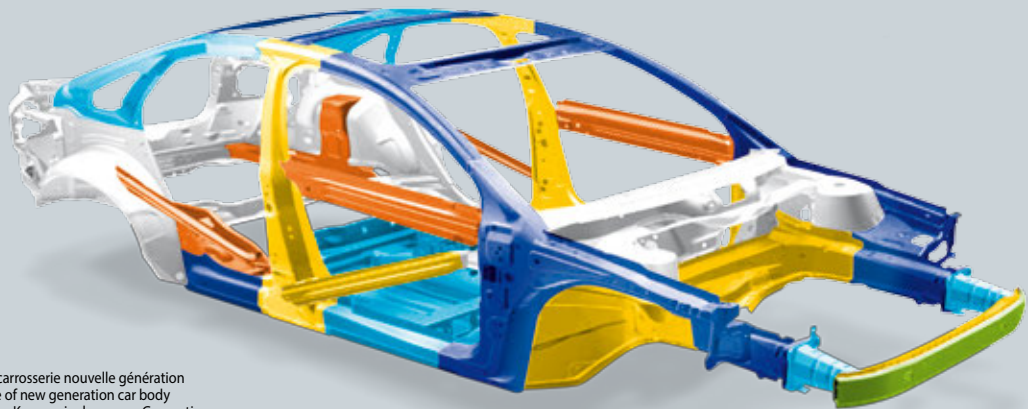

- Mild - Doux
- HSS - HLE
- VHSS - THLE
- UHSS - UHLE
- Bore - Boron
- Aluminium

Exemple de carrosserie nouvelle génération
 • An example of new generation car body
 • Beispiel einer Karosserie der neuen Generation
 • Ejemplo de la nueva generacion de carrocerias

HOMOLOGATIONS PRODUCTS

MANUFACTURER APPROVALS / COMPLIANCE - PRODUKT HOMOLOGATIONEN - PRODUCTOS HOMOLOGADOS



Product	Audi	BMW	Mercedes	Smart	Dacia	Jaguar	Land Rover	Other
GYSPT 2600								
GYSPT 39.02/04, PRO230/400								
PROLINER/SPEEDLINER/GYSLINER								
GYSPT ALU FV								
GYSPT 32D								
GYSPT INVERTER 100R								
GYSPT INVERTER BP-LX								
GYSPT INVERTER BP-LC-s7								
GYSPT INVERTER BP-LCX-s7								
GYSPT INVERTER BP-LQC-s7								
GYSPT EVOLUTION PTI-s7								
VAS 821 101 - Spot Welder								
T1 GYS AUTO								
T3 GYS AUTO								
NEOPULSE								
CUTTER 21/21KF								
CUTTER 31FV								
GYSDUCTION AUTO								

RANGE



		32 D	100 R	BP-s7	EVOLUTION PTI-s7
Doux - Mild	< 2,0 mm	•	•	•	•
	> 2,0 mm	•	•	•	•
HLE/THLE - HSS/VHSS	< 2,0 mm	•	•	•	•
	> 2,0 mm	< 2,5 mm	•	•	•
UHLE/BORE - UHSS/BORON	< 2,0 mm	Difficult	•	•	•
	> 2,0 mm	Difficult	•	•	•
Nombre de points (non stop : 10 points/min) - Number of spots (non stop : 10 spots/min)	$\frac{1}{4}$ 0,8 + 0,8 mm	25	30	2000	2000
	$\frac{1}{4}$ 2,5 + 2,5 mm	7	10	120	120
Inverter Technology		—	•	•	•
EMF Directive 2013/35/UE		—	—	BODY PROTECT TECHNOLOGY	•
Système de refroidissement - Cooling system		AIR	AIR	LIQUID	LIQUID
Régulation automatique - Automated regulation	I (A)	—	•	•	•
	daN	—	•	•	•
		irregular	constant	constant	constant
MODE AUTO		—	—	• (LC, LQC, LCX)	•
Pince - Clamp	X	• (32DX)	• (100R-X)	• (BPLX)	—
	C	• (32DC)	• (100R-C)	• (BPLC)	•
	X+C	—	• (100R-CX)	• (BPLCX)	—
Transformer Inside Clamp		—	—	—	•
Cables (L)		2,5 m	2,5 m	2,5 m	4 or 6 m
Includes gun		•	•	•	option
Fuse		32 A	32 A	32 A	25 A (14 500 A) 16 A (11 500 A)

BP BODYPROTECT TECHNOLOGY



UNIQUE ELECTRO-MAGNETIC FIELD PROTECTION by GYS

®BODY PROTECT is a proprietary GYS technology that minimises, electromagnetic fields created by the machine.

Compliant : Directive 2013/35/UE
Certified by : Laboratory EMITECH



MADE IN FRANCE

LA SOLUTION GLOBALE - THE GLOBAL SOLUTION

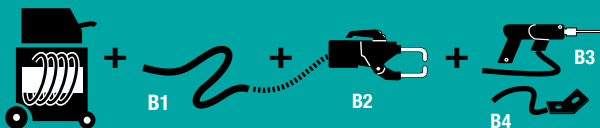

Other technologies

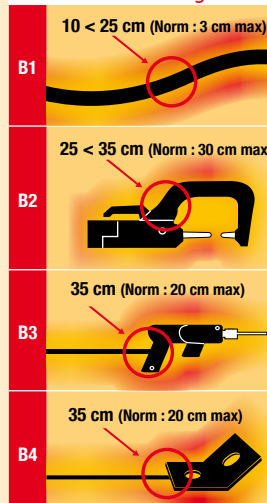

GYS BODYPROTECT TECHNOLOGY

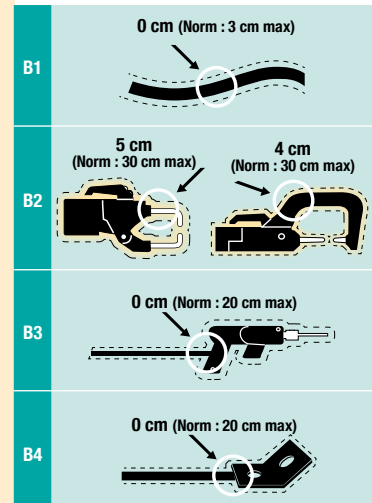

PORTASPOT 230

6 300 A - 120 daN

230V

022256



MADE IN FRANCE



DELIVERED WITH PX 1



ARMS Ø 25 mm

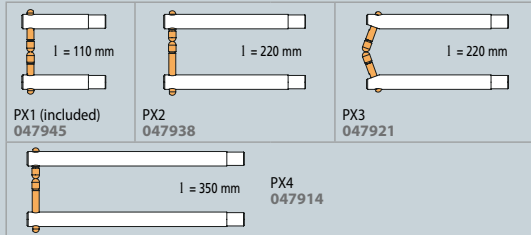

ELECTRODES

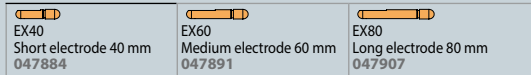

CAPS & ACCESSORIES



50/60 Hz	16(D)	6 300	8 900	2+2	2,45	2,5	3x2,5 H05VVF	100% CU	36x29 x10	10
50/60 Hz	A	A	A	mm	V	m	mm ²		(no arm) cm	kg

GYSLOT 32D-X

7 500 A

2x400V

019881

GYSLOT 32D-C

7 500 A

2 x 400V

019898



INCLUDED	RX1 051034	RX2 051041	RX3 051058	Monopoint Spot welding 049291	Inertia hammer 049482 + 049802	Caps remover 050846	Contact grease 050440	Spotter box	Top Spotter box	Cable support
32D-X	■	■	■	■	■	■	■	■	■	■
32D-C	■	■	■	■	■	■	■	■	■	■
32D-C Ref. 022850	■	■	■	■	■	■	■	Standard box	■	■
ACCESSORIES Ref. 022867	■	■	■	■	■	■	■	■	■	■



OPTION X & C ARMS p.40

Housse de protection - Protection cover - Schutzhaube 052260



GYSPOT INVERTER BP-LX

For mild steel, HSS, UHSS Boron steel

13 000 A
550 daN

Liquid cooled



6,5 kg (included X1)

Cable 2,5 m Ø 200 mm²

Double pressure

Ø 10 mm

3 x 400V
019652

BP BODYPROTECT TECHNOLOGY 2013/35/UE

UNIQUE ELECTRO-MAGNETIC FIELD PROTECTION by GYS

GYSPOT TRACEABILITY SOFTWARE included

SAVE spot welding configuration and EXPORT data



INCLUDED

	Monopoint/ Spot welding (x1) 049291
	SPOTTER BOX PRO (p.13) 050075
	Inertia hammer 049482 + 049802
	X1 8 bar / 550 daN (X arms Ø 25 mm) 050501



	050068		x10 (x20: 052239)		x18 (x6: 049987)
	x6 (x6: 049994)		x18 (x6: 049970)		x40 (x6: 049987)
	048935				



SD CARD
050914

CORAGARD CS 330 10l
Liquide de refroidissement
Cooling liquid
Kühlmittel
Enfriamento líquido
Refrigeração líquida
052246



Housse de protection
- Protection cover
- Schutzhaube
050853





Included
Support haute stabilité
-High stability support
Compatible gyro



054196

GYSPOT INVERTER BP-LC-s7 For mild steel, HSS, UHSS Boron steel

13 000 A
550 daN
Liquid cooled



6,5 kg (included C1) Cable 2,5 m Ø 200mm² Double pressure Ø 10 mm

3 x 400V
020757

BP BODYPROTECT TECHNOLOGY 2013/35/UE
UNIQUE ELECTRO-MAGNETIC FIELD PROTECTION by GYS

EDC ENERGY DYNAMIC CONTROL **Automatic C clamp**
AUTOMATIC MODE

GYSPOT TRACEABILITY SOFTWARE included
SAVE spot welding configuration and EXPORT data

INCLUDED	
	Monopoint/ Spot welding (x1) 049291
	SPOTTER BOX PRO (p.13) 050075
	Inertia hammer 049482 + 049802
	C1 8 bar / 550 daN 019140
	Arm panel
	NEW GYRO 360° for BP-LC 051737

OPTION

10-14 kg
GYRO 360° for BP-LC
051737

MADE IN FRANCE 60974/1	CE NORM	50/60 Hz	A	RMS A	U _o V	mm	Cables	100% CU	cm	kg			
											Liquid / Air Cooled	← m	Ø mm ²
GYSPOT BP.LX	019652	3 x 400V	32 (D)	13 000	16	3+3+3	1,5+3	Liquid	2,5	200	OK	65 x 80 x 205	160
GYSPOT BP.LC-s7	020757							Air	2,5	150			

**GYSPOT INVERTER
BP-LQC-s7**

 For mild steel,
HSS, UHSS Boron
steel

**13 000 A
550 daN**

Liquid cooled

 6,5kg
(included QC1)

 Cable 2,5m
Ø 200 mm²

Ø 10 mm

3 x 400V
021082

BP BODYPROTECT[®]
TECHNOLOGY 2013/35/UE

UNIQUE ELECTRO-MAGNETIC FIELD PROTECTION by GYS

ENERGY DYNAMIC CONTROL
Automatic C clamp
 AUTOMATIC MODE

GYSPOT TRACEABILITY SOFTWARE included
 SAVE spot welding configuration and EXPORT data

 Included Support haute stabilité
-High stability support
Compatible gyro

054196

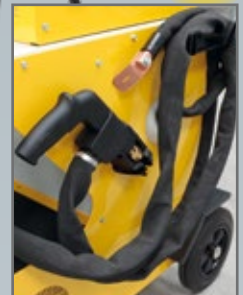
NEW

INCLUDED

	Monopoint/ Spot welding (x1) 049291
	SPOTTER BOX PRO 050075 p.13
	Inertia hammer 049482 + 049802
	QC1 021167 8 bar / 550 daN
	Arm panel

OPTION

 GYRO 360° for BP-LQC
053274 **10-14 kg**

 CORAGARD CS 330
10l

 Liquide de refroidissement
Cooling liquid
Kühlmittel
Enfriamiento líquido
Refrigeração líquida

052246

 Housses de protection
- Protection cover
- Schutzhaube

050853



MADE IN FRANCE CE NORMA 60974/1

50/60 Hz

A

A

mm

mm

 U_o

V

Cables

Liquid / Air Cooled

Liquid

Air

—

← m

 Ø mm²

100% CU

cm

kg

GYSPOT BP.LQC-s7 021082

3 x 400V

32 (D)
13000

3 + 3 + 3

1,5 + 3

16



048935

x40

(x6: 049987)

NEW • NEU

13 000 A

14 500 A

LIQUID COOLED

INVERTER



for : BP LQC

NEW GENERATION



MADE IN FRANCE

550 daN

6,5 kg including C1



LIQUID COOLED
REFROIDISSEMENT
LIQUIDE

Ø 10 mm

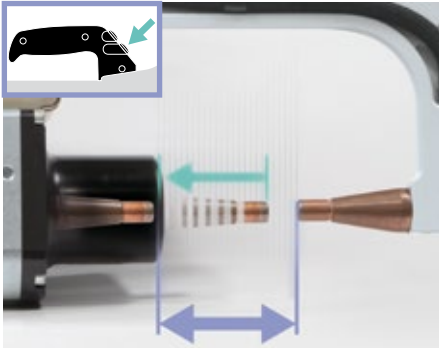

OPEN XL 80 mm

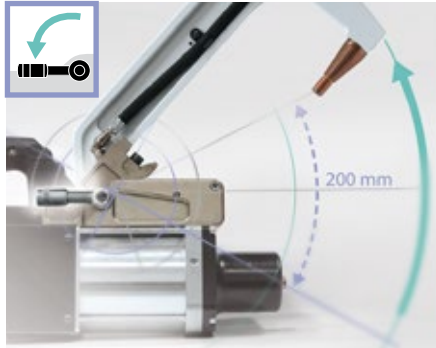

EASY

Aluminium nickelé
Pas d'oxydation,
Contact parfait
Durée de vie prolongée

- Nickel plated alu
- Alu (vernickelt)



CLEAN

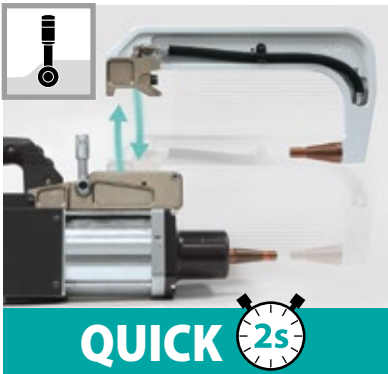

QUICK



PERFECT ELECTRICAL CONNECTION



AUTO

C Arms - Caps Ø13 mm

Bras isolés - Isolated arms - Isolierte Bügel



= Aluminium nickelé - Nickel plated aluminium - Aluminium (vernickelt)

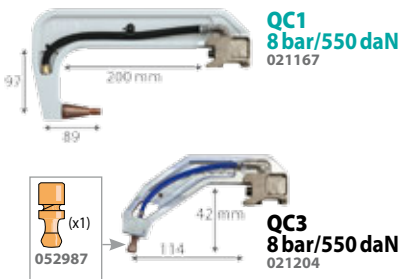

QC1
8 bar/550 daN
021167



QC4
8 bar/550 daN
021228



QC6
8 bar/550 daN
021259



QC5
4 bar/150 daN
021235

QC8
8 bar/550 daN
022751

NEW 10-2016

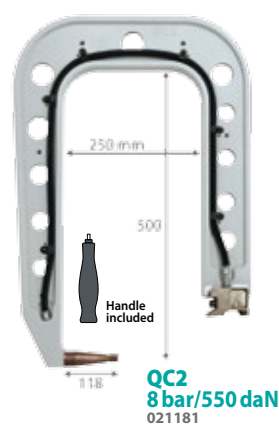

QC2
8 bar/550 daN
021181

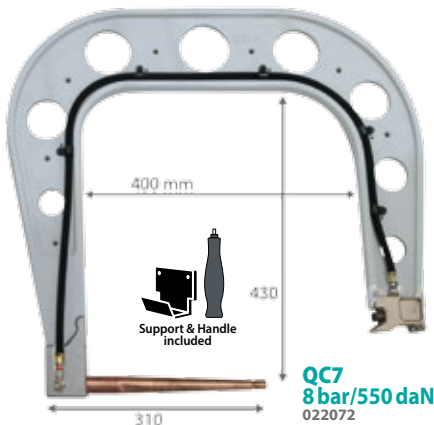

QC7
8 bar/550 daN
022072



QC9
8 bar/550 daN
022751

NEW 10-2016

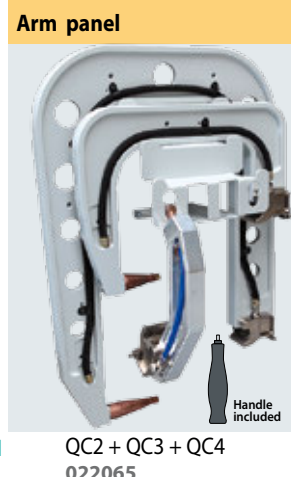

QC2 + QC3 + QC4
022065

Arm panel

INVERTER • LIQUID COOLED • QC CLAMP • 13 000 A



GYSPT SPOT INVERTER
BP-LCX-s7

For mild steel, HSS, UHSS
Boron steel

13 000 A
550 daN

Liquid cooled



6,5 kg (included X1 or C1)

Cable 2,5 m
Ø 200 mm²

Double pressure

Ø 10 mm

3 x 220V
020948

3 x 400V
020764

BP BODYPROTECT TECHNOLOGY
UNIQUE ELECTRO-MAGNETIC FIELD PROTECTION by GYS

EDC ENERGY DYNAMIC CONTROL
Automatic C clamp
AUTOMATIC MODE

GYSPT TRACEABILITY SOFTWARE included
SAVE spot welding configuration and EXPORT data

INCLUDED

	Monopoint/Spot welding (x1) 049291
	SPOTTER BOX PRO (p.13) 050075
	Inertia hammer 049482 + 049802
	C1 8 bar / 550 daN 021402
	X1 8 bar / 550 daN (X arms Ø 25 mm) 050501
	Arm panel

OPTION

	GYRO 360° for BP-LCX 051737 10-14 kg
--	--

	050068
	x10 (x20: 052239)
	x18 (x6: 049987)
	x6 (x6: 049994)
	x18 (x6: 049970)

	048935
	x40 (x6: 049987)



Included Support haute stabilité
-High stability support
Compatible gyro
+ 054196



NEW



SD CARD
050914

CORAGARD CS 330 10l
Liquide de refroidissement
Cooling liquid
Kühlmittel
Enfriamento líquido
Refrigeración líquida
052246



Housse de protection
- Protection cover
- Schutzhaube
050853





**GYSPOT INVERTER
EVOLUTION PTI-s7**

For mild steel,
HSS, UHSS

Boron steel

**14 500 A
550 daN**

Liquid cooled



TRANSFORMER INSIDE

FUSE
16 > 25 A

Cable 4 m or 6 m

Double pressure

Ø 10 mm

3 x 220V
4M 022188
6M 022195

3 x 400V
4M 020894
6M 020900

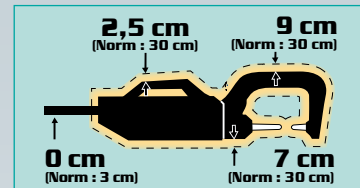

Compliant : Directive 2004-40-CE
Certified by : Laboratory **EMITECH**



AUTOMATIC MODE

GYSPOT TRACEABILITY SOFTWARE included

SAVE spot welding configuration and EXPORT data



INCLUDED

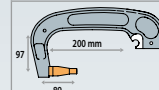

C1 isolé - insulated
8 bar / 550 daN
021402



Arm panel



OPTION

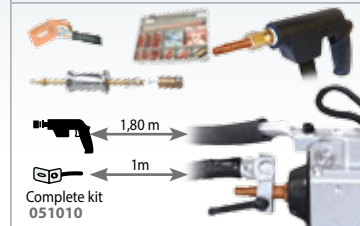

Very light
10,5 kg

MADE IN FRANCE 60974/1	CE NORM.	Cable	A	RMS A	U _o V	mm		Cables			100% CU	cm	kg
						↕	↔	↕	↔	↕			
GYSPOT BP.LCX-s7	020764	3 x 400V	32 (D)	13 000	16								
GYSPOT BP.LCX-s7 220 V	020948	3 x 200 208 220 240	63 (D)	10 500 11 000 12 000 12 500	15 15,5 17 18	3 + 3 + 3	1,5 + 3	2,5 m, Ø 200 mm ² , Liquid	2,5 m, Ø 150 mm ² , AIR	8 m, 4x6 H07RNF (BP 220V-4x16)	OK	65 x 80 x 205	180
GYSPOT EVOLUTION PTI-s7	4M 020894 6M 020900	3 x 400V	25 (D) 16 (D)	14 500 11 500	8			4 m, Liquid 6 m, Liquid		8 m, 4x4 H07RNF			
GYSPOT EVOLUTION PTI-s7 220 V	4M 022188 6M 022195	3 x 200 208 220 240	40 (D) 14500A 32 (D) 11500A	12 500 13 000 14 500 14 500	6,95 7,2 8 8,3	3 + 3 + 3	1,5 + 3	4 m, Liquid 6 m, Liquid	OPTION 051010 : 1,5 m, Ø 200 mm ²	8 m, 4xAWG8 (500W)	OK	65 x 80 x 230	100

550 daN

6,5 kg including X1

DOUBLE PRESSURE

LIQUID COOLED
REFROIDISSEMENT LIQUIDE

Ø 10 mm



MADE IN FRANCE

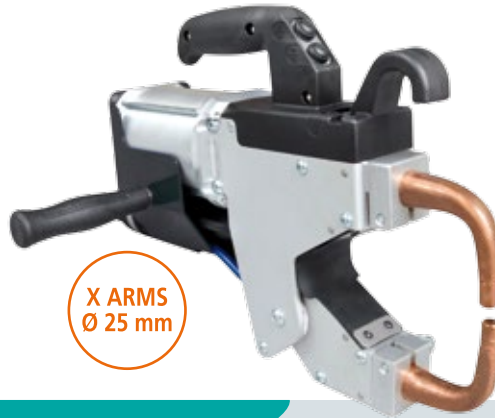

X ARMS
Ø 25 mm

Remote control (BP)



Digital screen control
Change Mode & Parameters



Clamp control



X Arms - Caps Ø13 mm

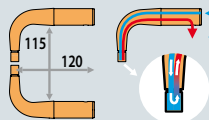

X1 8 bar/550 daN
050501

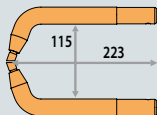

X2 8 bar/400 daN
050518



Ø 10 (x2)
052895

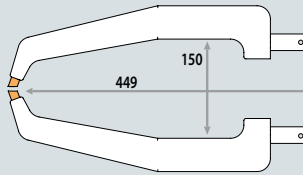

X4 8 bar/120 daN
050532

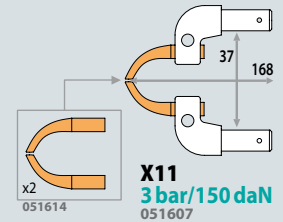

X11 3 bar/150 daN
051614
051607

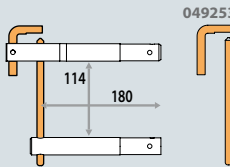

X5 8 bar/200 daN
050549



X4A 8 bar/150 daN
020702

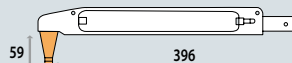

X4B 8 bar/150 daN
020719

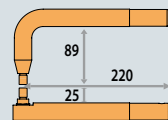

X6 8 bar/400 daN
050587

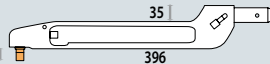

X4C 8 bar/150 daN
020726

X4 (A, B & C) combinations

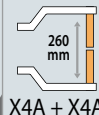

X4A + X4A

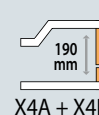

X4A + X4B

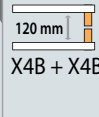

X4B + X4B

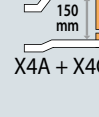

X4A + X4C

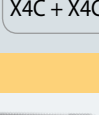

X4C + X4C

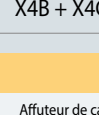

X4B + X4C

Arm panel

X4A (x2) + X5 + X2
022324

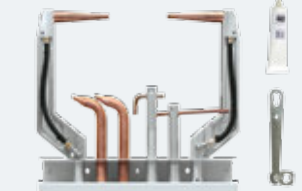

X4A (x2) + X4B + X4C + X2
020733

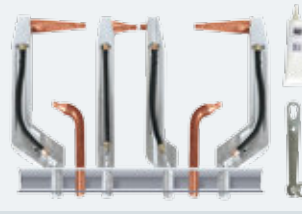

Consommables X & C - X & C Consumables

Type A
Cor X clamp
Ø 13 mm (x6)
049987

Type B
Cor X clamp
Ø 13 mm / Ø 5 mm (x6)
055506

Type C
X2, X4, C11 arms
Ø 13 mm (x6)
049994

TYPE F
For single sided gun
Ø 13 mm (x6)
049970

Eurapax anti-corrosion
052758
500 ml



Lame - Blade
052857

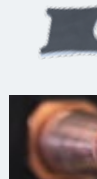

Affuteur de caps - Cap grinder
048966



GYRO 360°



10-14 kg

for BPLC/BPLCX
051737



for EVOLUTION
051720

Graisse contact
Contact grease
050440

Caps remover
050846



Boîte consommables Spotter
• Welding Spotter consumables
• Zubehör für Punktschweißanlagen
050068

BANC DE TRACTION ARRACHE TÔLE - Steel sheet traction bench - Blech-Zugbank zur Festigkeitsprüfung

052420



052321 (included)

CAPTEUR D'EFFORT - Electrode force sensor

052314



VALISE DE TEST SOUDURE - Weld test kit - Schweißtestkit im Hartschalenkoffer

050433



Tôle/Sheet/
Schweißprobenbleche
HLE / HTS
1,0 mm (x150)
050181
2,5 mm (x150)
050167

ÉCHANTILLONS DE TÔLES - Sheets set

Acier/Steel
0,8 (x65) + 1 (x55)
+ 1,5 (x35) + 2 (x25)
+ Alu
1 (x45) + 1,5 (x30)
+ 2 (x20)
055841

GYSTEEL VISION

051096



IDENTIFIEZ VOTRE ACIER - STEEL IDENTIFICATION
- IDENTIFIZIEREN SIE DIE STAHLHÄRTE

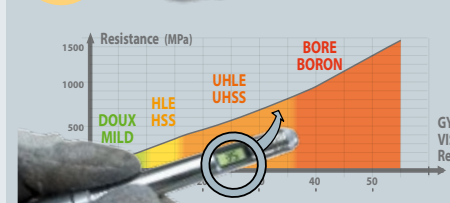

Register online
test certificate



MADE IN FRANCE

550 daN

6,5 kg including C1

- DOUBLE PRESSURE**
- LIQUID COOLED**
REFROIDISSEMENT LIQUIDE
- Ø 10 mm**



MADE IN FRANCE

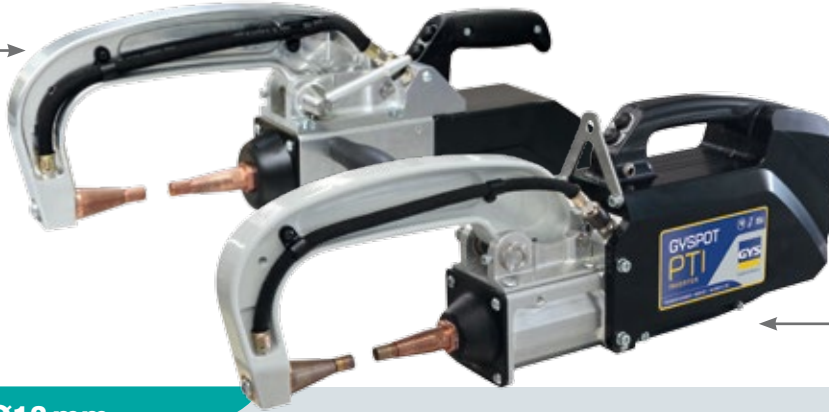

550 daN

Transformer inside

10,5 kg including C1

- DOUBLE PRESSURE**
- AIR COOLED + LIQUID COOLED**
- DOUBLE REFRROIDISSEMENT**
AIR + LIQUIDE
- Ø 10 mm**

C Arms - Caps Ø13 mm

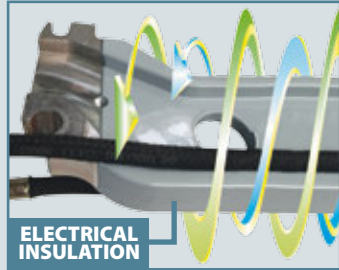

Remote control (BP)



Arm panel



■ Bras isolés - Isolated arms - Isolierte Bügel & ■ Classic arms

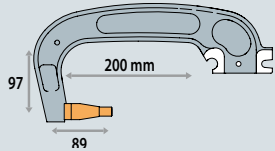

C1 8 bar/550 daN

- 021402
- 019140

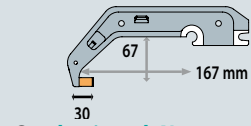

C5 8 bar/550 daN

- 022393
- 019294

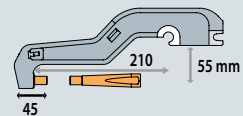

C2 8 bar/550 daN

- 022386
- 019133

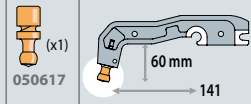

C6 8 bar/300 daN

- 022409
- 019775

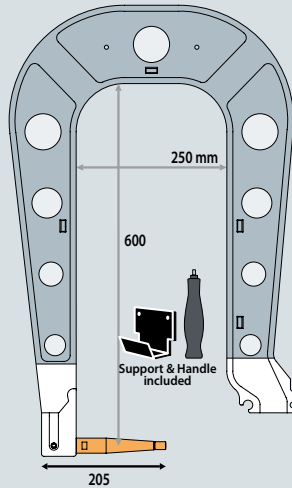

C9 8 bar/550 daN

- 020078

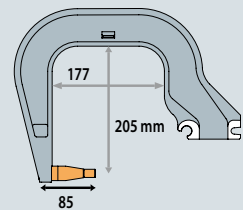

C3 8 bar/550 daN

- 021419
- 019157

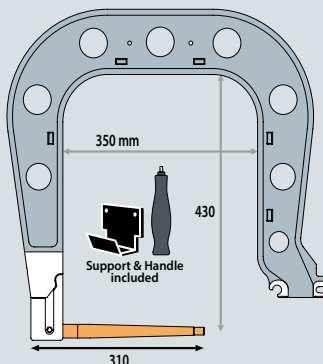

C7 8 bar/550 daN

- 021433
- 020009

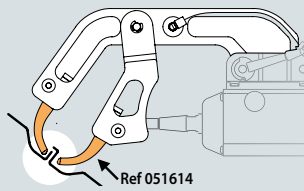

C10 4 bar/150 daN

- 051638

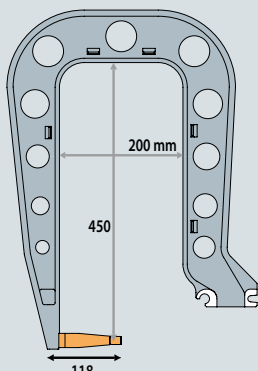

C4 8 bar/550 daN

- 021426
- 019164

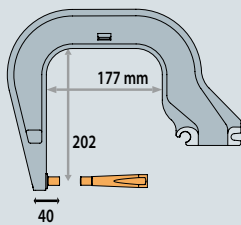

C8 8 bar/550 daN

- 021440
- 020016

X Arms - Caps Ø13 mm

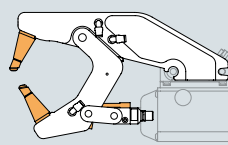

C11 8 bar/550 daN

- 053649

C2 + C3 + C5 + C6 + C9
050044

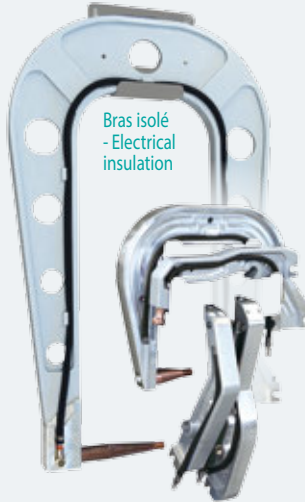

C2 + C3 + C4
021457

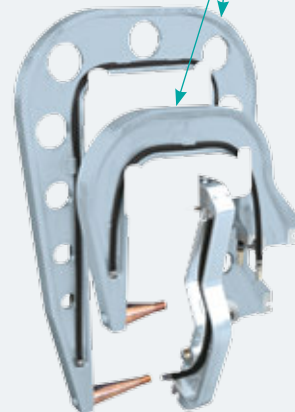



UNIVERSAL CAR BODY RIVETING SYSTEM 8t

(7840 daN)

PNEUMATIC HYDRAULIC

BRAS DE RIVETAGE (HR)

- Riveting arms (HR) - C-Bügel

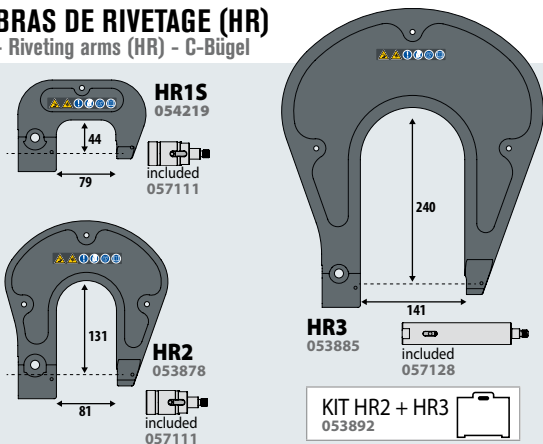

POINTEAU CENTREUR - Special center punch - Spezialkörner



OPTIONS

Support Riveteuse pour changements d'accessoires (bras & matrice)
 - Riveting machine support for changing accessories (arms & dies)
 - Supportständer

↳ 28 x 40 x 21,5 cm
 054158

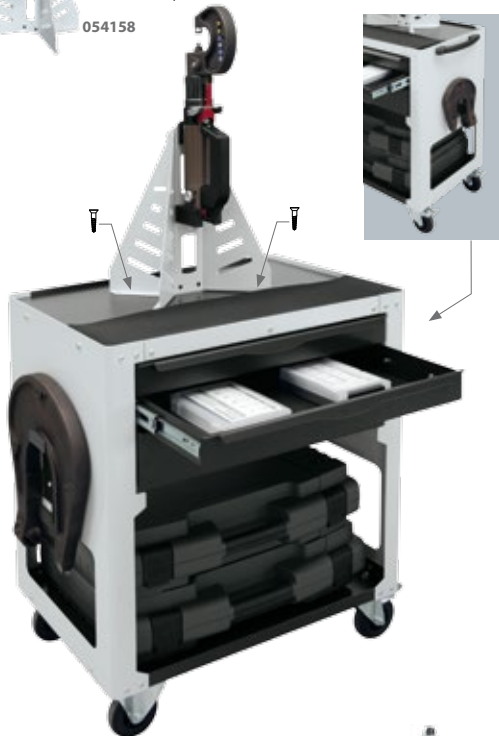

Chariot-Trolley
 ↳ 51 x 82 x 74 cm
 054233

Chariot+Support
 -Trolley+Support
 ↳ 51 x 122 x 74 cm
 055391

DIES TOOL BOX - Kit matrices - Matrizen-Kit

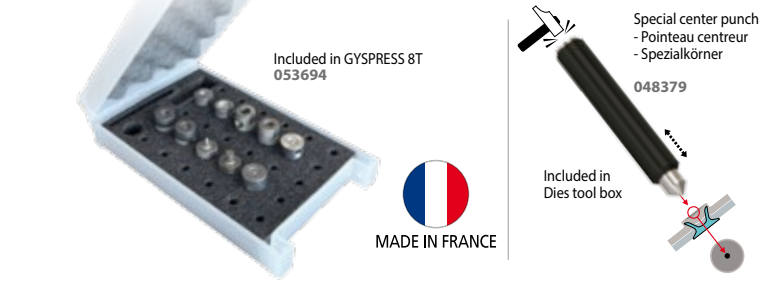

Pose de rivets auto-perçants Ø 3,3 mm - Application of self-piercing rivets Ø 3,3 mm - Stanzniet-Verpressen Ø 3,3 mm		Pose de rivets auto-perçants Ø 5,3 mm - Application of self-piercing rivets Ø 5,3 mm - Stanzniet-Verpressen Ø 5,3 mm		Extraction de rivets auto-perçants - Extraction of self-piercing rivets - Stanzniet-Auspressen	
A1 055698	A2 055704	B1 055711	B2 055728	E1 055865	E2 055766
A1 + A2 set 054295		B1 + B2 set 054301		E1 + E2 set 054318	
Perçage des tôles Ø 6 mm - Metal sheet punching Ø 6 mm - Lochstanzen Ø 6 mm		Pose de rivets Flow-Form Ø 6 mm - Application of Flow-form rivets - Setzen v. Fließformnieten			
T1 057098	T2 057104	F1 055773	F2 055780	clé plate	joints
T1 + T2 set 054707		F1 + F2 set 054714			

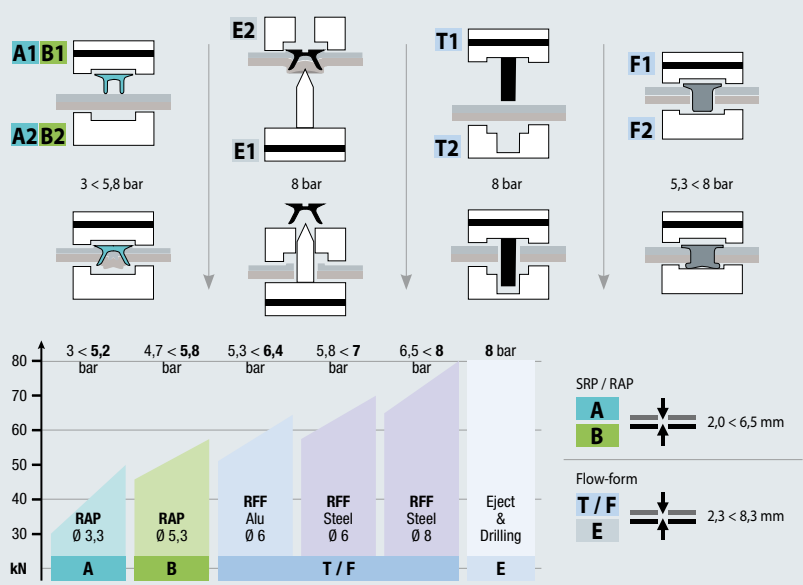

SELF-piercing rivets (SPR) - Rivets auto-perçants (RAP) - Stanznieten

Steel - Acier - Stahl							
Ø 3,3 x 3,5 mm x 200	Ø 3,3 x 4 mm x 200	Ø 5,3 x 4 mm x 100	Ø 5,3 x 5 mm x 100	Ø 5,3 x 6 mm x 100	Ø 5,3 x 7 mm x 100	Ø 5,3 x 8 mm x 100	Ø 5,3 x 9 mm x 100
048232	048249	048256	048263	048270	048638	048225	048645



GYPRESS 8T

053861



UNIQUE
100% ~~Oil Leak~~
No Oil Leak
 maintenance free, no oil refill

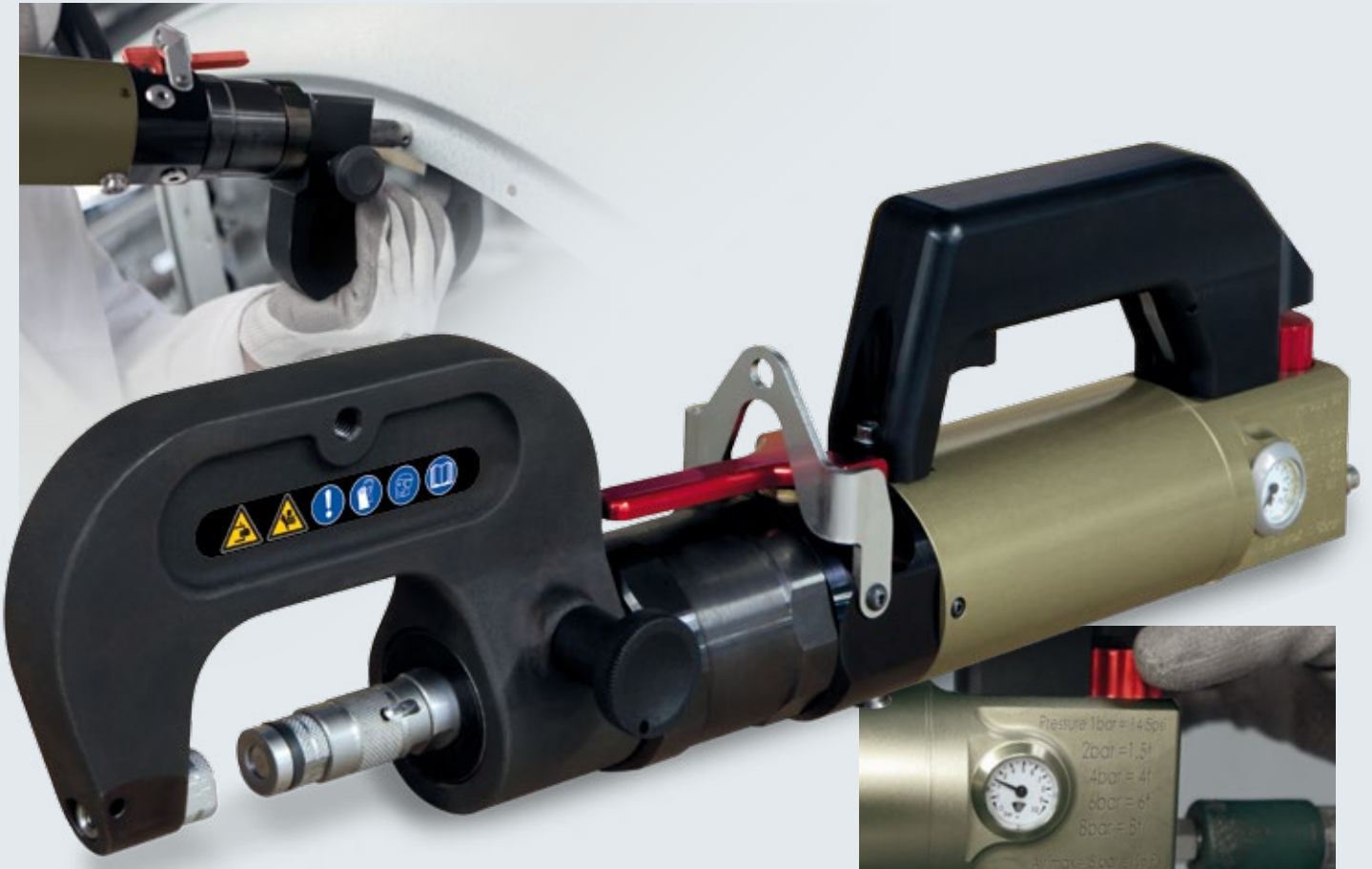

PRESSURE CONTROL - Druckregelung



**SPEED CONTROL - Regelung
 Werkzeuggeschwindigkeit**



DISCHARGE LEVER - Auslösehebel

INCLUDED

	Die tool box (2 clés + centreur inclus)
	Dies tool box (2 keys + special center punch included) 053694
	HR arm locker
	Strap Sangle Gurt
	Poignée Handle Griff
	6 x 50 rivets - Nieten RAP/SPR ACIER / STEEL / STAHL Ø 3,3 x 3,5 mm Ø 5,3 x 4,0 mm Ø 3,3 x 4,0 mm Ø 5,3 x 5,0 mm Ø 5,3 x 6,0 mm Ø 5,3 x 8,0 mm



	AIR BAR	PRESSURE CONTROL	SPEED CONTROL			
MADE IN FRANCE				cm	kg	kg
GYPRESS 8t	053861	8 bar = 8 t maxi 10 bar	0 > 8 bar	58 x 48 x 15	6	11,3

KIT MATRICES RMB 01 - Dies tool box - Matrizen-Kit



For BMW
054240



MADE IN FRANCE

Pose de rivets auto-perçants Ø 3,3 mm - Application of self-piercing rivets Ø 3,3 mm - Stanzniet-Verpressen Ø 3,3 mm		Pose de rivets auto-perçants Ø 5,3 mm - Application of self-piercing rivets Ø 5,3 mm - Stanzniet-Verpressen Ø 5,3 mm		Extraction de rivets auto-perçants - Extraction of self-piercing rivets - Stanzniet-Auspressen		clé plate joints	
A1 055698	A2 055704	B1 055711	B2 055728	E1 055865	E2 055766		
						x2	x4

KIT MATRICES RMB 02 - Dies tool box - Matrizen-Kit

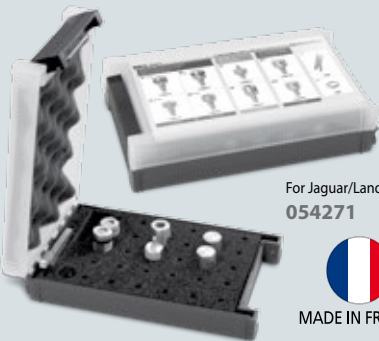

For Jaguar/Land Rover
054271



MADE IN FRANCE

Pose de rivets auto-perçants Ø 4,8 mm - Application of self-piercing rivets Ø 4,8 mm - Stanzniet-Verpressen Ø 4,8 mm		Extraction de rivets auto-perçants - Extraction of self-piercing rivets - Stanzniet-Auspressen		Applanissement des tôles - Metal sheet levelling - Blech-Rückverformung		clé plate joints	
B2 055728	B3 055735	E1 055865	E6 057142	D17 055681			
						x2	x4

KIT MATRICES RMB 03 - Dies tool box - Matrizen-Kit



For VW Group
054257



MADE IN FRANCE

Pose de rivets auto-perçants Ø 3,2 mm et Ø 3,5 mm - Application of self-piercing rivets Ø 3,2 & 3,5 mm - Stanzniet-Verpressen Ø 3,2 & 3,5 mm		Pose de rivets auto-perçants Ø 5,3 mm - Application of self-piercing rivets Ø 5,3 mm - Stanzniet-Verpressen Ø 5,3 mm			Pose de rivets pleins Ø 4,0 mm - Application of solid rivets Ø 4,0 mm - Vollniet-Verpressen Ø 4,0 mm			clé plate	
A1 055698	S3 057043	B1 055711	S7 057074	S8 057081	D8 056039	D9 056046			
Pose de rivets pleins Ø 6,0 mm - Application of solid rivets Ø 6,0 mm - Vollniet-Verpressen Ø 6,0 mm		Extraction de rivets auto-perçants Ø 3,2 mm - Extraction of self-piercing rivets Ø 3,2 mm - Stanzniet-Auspressen Ø 3,2 mm			Extraction de rivets auto-perçants Ø 5,3 mm - Extraction of self-piercing rivets Ø 5,3 mm - Stanzniet-Auspressen Ø 5,3 mm			joints	
D17 055681	S1 057036	D1 055971	D2 055988	D3 055995	D4 055742	S4 057050	D5 056008		S5 057067
Extraction de rivets pleins Ø 6 mm - Extraction of solid rivets Ø 6,0 mm - Vollniet-Auspressen Ø 6,0 mm		Perçage et formage des tôles pour rivets pleins Ø 4,0 mm - Metal sheet punching and shaping Vollniet-Lochstanzen/Prägen Ø 4,0 mm		Perçage et formage des tôles pour rivets pleins Ø 6,0 mm - Metal sheet punching and shaping Vollniet-Lochstanzen/Prägen Ø 6,0 mm		Perçage et formage des tôles pour rivets POP Ø 4,8 mm - Metal sheet punching for POP rivets - Lochstanzen f. Blindniet Ø 4,8 mm		Perçage de tôles Ø 8 mm pour bouchonnage (D12 + D5) - Metal sheet punching - Lochstanzen f. Schweißverbindung Ø 8 mm	
D13 055759	E2 055766	D10 055674	D11 056060	D15 056077	D16 056084	D6 056015	D7 056022	D12 056053	
									x4



For Mercedes-Benz
054264



MADE IN FRANCE

Perçage des tôles Ø 6 mm - Metal sheet punching Ø 6 mm - Lochstanzen Ø 6 mm		Perçage des tôles Ø 8 mm - Metal sheet punching Ø 8 mm - Lochstanzen Ø 8 mm		Extraction de rivets Ø 6 mm - Extraction of rivets Ø 6mm - Niet-Auspressen Ø 6 mm		Extraction de rivets Ø 8 mm - Extraction of rivets Ø 8mm - Niet-Auspressen Ø 8 mm	
T1 057098	T2 057104	T3 055827	T4 055834	E4 057012	E3 057005	E5 057029	
Pose de rivets Flow-Form Ø 6 mm - Application of Flow-form rivets - Setzen v. Fließformnieten		Pose de rivets Flow-Form Ø 8 mm - Application of Flow-form rivets Ø 8 mm - Setzen v. Fließformnieten Ø 8 mm		Rivets : S08, S18		Rivets : S28, S38, S48, S58, S68	
F1 055773	F2 055780	F3 055797	F4 055803	F5 055810	clé plate		 for HR3 arm (use with E3, E4, E5) 057135

KIT MATRICES RMB 05 - Dies tool box - Matrizen-Kit



For Ford
055872



MADE IN FRANCE

Pose de rivets auto-perçants Ø 5 mm - Application of self-piercing rivets Ø 5 mm - Stanzniet-Verpressen Ø 5 mm						Extraction de rivets Ø 5 mm - Extraction of rivets Ø 5mm - Niet-Auspressen Ø 5 mm		clé plate	joint	
B1 055711	G1 057173	G2 057180	G3 057197	G4 057203	G5 057210	G6 057227	E7 057159	E8 057166		
								x 2		x 4

RIVETEUSE HYDRO-PNEUMATIQUE - Hydropneumatic tool for blind rivets - Hydro-pneum. Blindnietgerät

Rivets POP - POP rivets
- Blindniet



HR9

Pour rivets
Ø 3,2/4,0/4,8 mm
(Acier/Alu - Steel/Alu)

max 9 000 N

057234



Made in Taiwan

RIVETEUSE HYDRO-PNEUMATIQUE RIV 508 - Hydropneumatic tool for blind rivets - Hydro-pneum. Blindnietgerät

Rivets POP - POP rivets
- Blindniet



Pour la pose de rivets de structure
max 21 000 N (6 bar)

livré avec kit pour pose de rivets Ø 4,8 à Ø 7,8 mm
055407



MADE IN ITALY



Rivets POP - POP rivets
- Blindniet



HR14

Pour rivets
Ø 4,0/4,8/6,4 mm
(Acier/Alu - Steel/Alu)

max 14 000 N

057241

Made in Taiwan

SERTISSEUSE HYDRO-PNEUMATIQUE RIV 998 - Hydropneumatic tool for rivet nuts - Hydro-pneum. Blindnietmuttergerät

Ecrous à sertir
- Sealing nuts
- Blindnietmuttern



Pour la pose d'écrous à sertir M4 à M12
max 19 000 N (6 bar)

livré avec accessoires pour écrous à sertir M4 à M12
055414



MADE IN ITALY



15 A → 200 A
Ideal 0,6 mm

CAPACITOR INSIDE → PERFECT WELD
 M1GYS AUTO, M3GYS AUTO

ENERGY SAVING

CARMIG 400V 3~

with accessories: 032132

NEW 12/2015

M1GYS AUTO CAPACITOR INSIDE

with accessories:

230V 1~ 032903

208/240V 1~ 032088

T1GYS AUTO 400V 3~

with accessories: 032910

T1GYS AUTO DV 230V 3~/400V 3~

with accessories: 032927

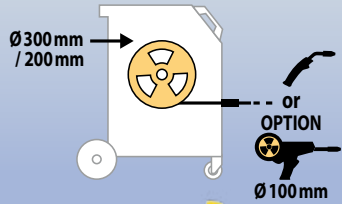

ACCESSORIES BOX

Torche motorisée Spool Gun - Spool Gun Torch
 - Spool Gun Brenner

041486

Ø 100

Ideal for
 - Acier / Steel / Stahl
 - Inox / Stainless steel
 - Alu

4m

included 045699

BINZEL

OPTIONS

 20L / min (FR) 041998 (UK) 040274 (NL) 040267	Préchauffeur de gaz - Gas preheater for CO ₂ pur or CO ₂ /Ar 230 V - power: 25 W max pressure: 200 bar IP 44 - 1.5 kg (FR) 046511	 041332	 T3GYS & M3GYS: Housse de protection - Protection cover - Schutzhaube 048874
 OPTIMAPRO 30L / min (FR) 043619 (UK) 043633 (EN) 043626 (NL) 043640	 2 m 041806	 for M3/T3 041493	
 30L / min (FR) 041622 (UK) 041646 (DE) 041219 (NL) 041615			



M3GYS AUTO CAPACITOR INSIDE

with accessories:

230V 1~ 032880

208/240V 1~ 032897

T3GYS AUTO 400V 3~

with accessories:

032958

with accessories:

032941

T3GYS AUTO DV 230V 3~/400V 3~

with accessories:

032972



SYNERGIC - EASY TO USE

Réglage automatique de la vitesse \ Auto adaptative wire speed
Automatische Einstellung der Drahtgeschwindigkeit

PATENTS REGISTERED NUMBERS
EUROPEAN TRADEMARK & DESIGN

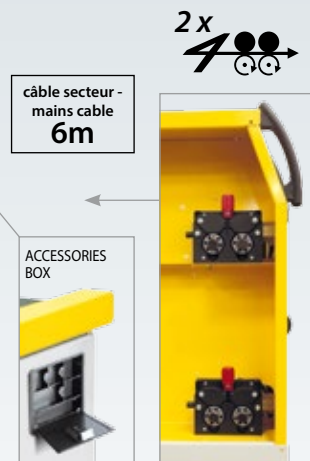
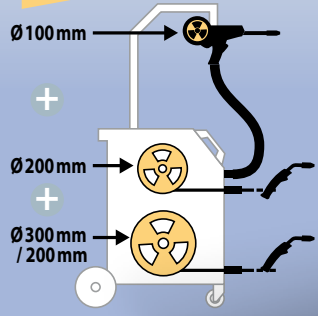

Échantillons de tôles - Sheets set

- Acier/Steel: 0,8 (x65) + 1 (x55) + 1,5 (x35) + 2 (x25)
- + Alu: 1 (x45) + 1,5 (x30) + 2 (x20)

055841

Protection gas
Argon+Co. (Steel, Inox)
Argon (ALU/CuSi3/CuAl8)
Co_PUR

MADE IN P.R.C.	CE NORM. 60974/1	50/60 Hz	A	min → max	Reg	Ø mm			Electronic Control	EN60974-1 (40°C)		Ø mm	cm/kg	Protected & compatible power generator (+/-15%)			
						100 (spoolgun)	200	300		IA (60%)	X% (I2 max)						
CARMIG	032132	400V 3~	10	15 → 200	7	-	■	■	Electronic	110	150A@25%	0,6+1	0,6/0,8	0,8	47x77x79 / 50	5 kVA	
	M1GYS AUTO	032903	230V 1~	16	15 → 160	6	option	■	■	90	140A@15%	0,6+1	0,6/0,8	0,8	47x77x79 / 50	4,5 kVA	
	T1GYS AUTO	032088	208/240V 1~	10	15 → 200	7	option	■	■	110	150A@25%	0,6+1	0,6/0,8	0,8	47x77x79 / 55	5 kVA	
	T1GYS AUTO DV	032910	400V 3~	10	15 → 200	7	option	■	■	110	150A@25%	0,6+1	0,6/0,8	0,8	47x77x79 / 55	5 kVA	
	M3GYS AUTO	032927	230V 3~/400V 3~	10	15 → 200	7	option	■	■	110	150A@25%	0,6+1	0,6/0,8	0,8	47x77x79 / 55	5 kVA	
	M3GYS AUTO	032880	230V 1~	16	15 → 160	6	■	■	■	90	140A@15%	0,6+1	0,6/0,8	0,8/1,0	2x0,8	60x90x90 / 67	4,5 kVA
	T3GYS AUTO	032897	208/240V 1~	16	15 → 160	6	■	■	■	90	140A@15%	0,6+1	0,6/0,8	0,8/1,0	2x0,8	60x90x90 / 67	4,5 kVA
T3GYS AUTO	032958	400V 3~	10	15 → 200	7	■	■	■	110	150A@25%	0,6+1	0,6/0,8	0,8/1,0	2x0,8	60x90x90 / 72	5 kVA	
T3GYS AUTO DV	032972	230V 3~/400V 3~	10	15 → 200	7	■	■	■	110	150A@25%	0,6+1	0,6/0,8	0,8/1,0	2x0,8	60x90x90 / 72	5 kVA	



MIG / MANUAL
Enter your parameters

MMA

TIG lift



Adjust Spot & Delay

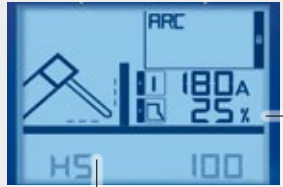

HotStart

ArcForce



Post Gas

Downslope

MIG / SYNERGIC
Easy to use



Select:

- 1. material
 - 2. Ø wire
 - 3. position
 - 4. thickness
- Adjust arc length

4 in 1

GAS
NO GAS
MMA
TIG

Multi PEARL 201-4

20 200 A

Ø 200 / 300

PFC FV SR MMA GAS NO GAS TIG

with accessories:
031821



Multi PEARL 200-2

20 200 A

Ø 100 / 200

PFC FV SR MMA GAS NO GAS TIG

with accessories:
031944



Multi PEARL 200-4 XL

20 200 A

Ø 200 / 300

PFC FV SR MMA GAS NO GAS TIG

with accessories:
031791



MADE IN FRANCE EN60974-1	50 / 60 Hz	A	INTEGRATED TECHNOLOGY			I ₂ MMA	I ₂ TIG	min → max	MIG			EN60974-1 (40°C)	U _o (V)	cm / kg	Protected & compatible power generator (+/-15%)					
			PFC	FV	SR				Electronic Control	GAS	NO GAS					IA (60%)	X% (I ₂ max)			
Multi PEARL 200-2	110V 1~	32	■	■	■	10 → 130	10 → 180	20 → 150	■	■	—	0.6 + 1.0	0.9	110	150 A @ 22%	85	0.6 / 0.8	0.8	25 x 45 x 35 / 16	7.5 kW
	230V 1~	13				10 → 200	10 → 200	20 → 200						135	200 A @ 20%					
	110V 1~	32	■	■	■	10 → 130	10 → 180	20 → 150	■	■	■	0.6 + 1.0	0.9	110	150 A @ 22%					
Multi PEARL 200-4 XL	230V 1~	13				10 → 200	10 → 200	20 → 200	■	■	■	0.6 + 1.0	0.9	135	200 A @ 20%	85	0.6 / 0.8	0.8	25 x 55 x 44 / 20	7.5 kW
	110V 1~	32	■	■	■	10 → 130	10 → 180	20 → 150	■	■	■	0.6 + 1.0	0.9	110	150 A @ 22%					
	230V 1~	13				10 → 200	10 → 200	20 → 200	■	■	■	0.6 + 1.0	0.9	135	200 A @ 20%					
Multi PEARL 201-4	110V 1~	32	■	■	■	10 → 130	10 → 180	20 → 150	■	■	■	0.6 + 1.0	0.9	110	150 A @ 22%	85	0.6 / 0.8	0.8		7.5 kW
	230V 1~	13				10 → 200	10 → 200	20 → 200	■	■	■	0.6 + 1.0	0.9	135	200 A @ 20%					



EN 1090



PROMIG 350-4S
Compact 40▲350 A

no accessories
035898



PROMIG 350 G.DV
Generator 40▲350 A

no accessories
035904

PROMIG 350-4S DUO.DV
Compact DUO 40▲350 A

no accessories :
035911

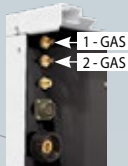

INVERTER MIG & TRUCK REPAIR MIG



CONNECTION CABLES
FAISCEAUX DE LIAISON

L	AIR COOLED	Ø
5 m	034822	50 mm ²
5 m	034839	70 mm ²
10 m	034853	50 mm ²
10 m	034860	70 mm ²
10 m	045941	95 mm ²



OPTION
PROMIG 350 G.DV, 350-4S DUO.DV

TF 4R



033849

Câble d'inversion de polarité
Polarity reversal cable Ø 95 mm²
1.3 m
033689

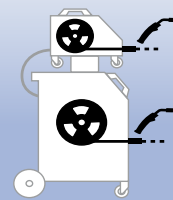

2 TORCHES

 MADE IN FRANCE	 EN60974-1	 50/60 Hz	 A	 Ø mm	 min → max		 Ø mm	Equipement d'origine Original equipment Originalausstattung Equipamiento de fabrica	 ELECTRONIC CONTROL	Cooling system	EN60974-1 (40°C)		 Reg	 cm / kg	 Protected & compatible power generator (+/-15%)
											IA (60%)	X% (I2 max)			
PROMIG 350-4S		400V 3~	16 (20)	—	40 → 350	■	—	■	 1.0 / 1.2 mm	Air	270	350 A @ 35%	14	50 x 90 x 88 / 102	17 kVA
PROMIG 350 G.DV		230V 3 ~& 400V 3~	230V : 25 (40) 400V : 16 (25)	—	40 → 350	—	+ TF4R	■	 —	Air	270	350 A @ 35%	14	50 x 90 x 88 / 102	17 kVA
PROMIG 350-4S DUO.DV	0.8 → 1.2														
TF 4R		—	—	0.8 → 1.2	—	—	—	■	 1.0 / 1.2 mm	Air	—	—	—	59 x 44 x 30	—

MIG/MAG INVERTER DOUBLE PULSE

400 V · 3 Φ



SIZE N°1 ON MARKET
5" 1/4 ERGONOMIC & EASY

Ø 1.0mm	Fe_ARG CO2	STD	4T
			2T
			4T

STANDARD MODE
EASY & INTUITIVE

U=52V I=215A

OPTION	PRO	Ø 1.0mm	Al_Mg5ARG	PULSE	2T
		8 m/min	+ mm	I (A)	
		1.9	1.0	59	
		U (V)	-2	0	
		12.6			

PRO MODE
100% PARAMETERS

★ ★ ★ Ideal Alu & CuAl8/CuSi3

SQS SOFT QUICK START ©
Vitesse d'accostage contrôlée

SOFT QUICK START

NEOPULSE 270-T1
15 **270 A**

no accessories/no trolley :
022454

NEOPULSE 270-T2
15 **270 A**

FV TRI no accessories/no trolley :
021983

SCREEN PROTECTION (x5)
044043



OPTIONS

FV TRI FLEXIBLE VOLTAGE



Potence - Cable support



for Neopulse 270-T1/270-T2/300
032842

for Neopulse 300-T2
022553



845 x 982 x 605 mm
033931

Max 10 m³ (50L)



INCLUDED Connection
034273

WCT 1.3kW A

400 V, 2~
1300W,
cooling unit (5l)
020344

WCT 1.3kW C

230 V, 2~
1300W
cooling unit (5l)
032781



CORAGARD CS 330 (10 L)
052246

Stable arc / Constant penetration
Arc stable / pénétration constante

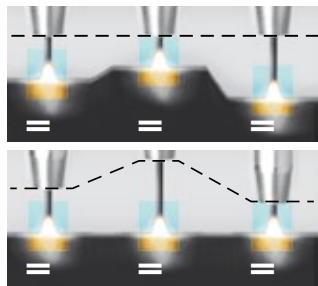

Adjustable inductance
Inductance réglable

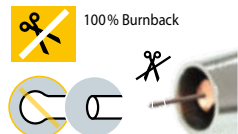
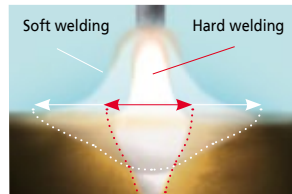

Spatter free
- Pas de projection
- Keine Spritzer

Difficult Access
- Accès difficile
- Problempositionen

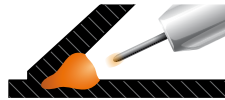

Gap-Bridging
- Referement de jour
- Spaltüberbrückung



4 DRIVE ROLLERS
ø37 mm, MOTOR 75W
Rollers Type C



ELECTRONIC

DSP FULLY DIGITAL
RJ12 - Software update

SYNERGIES UPDATE
- Mise à jour des synergies



SD CARD
050914



NEOPULSE 300
15 270 A
FV TRI no accessories/no trolley :
032767

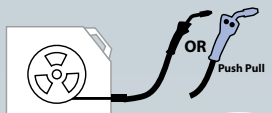

NEOPULSE 300-T2
15 270 A
FV TRI no accessories/no trolley :
032729

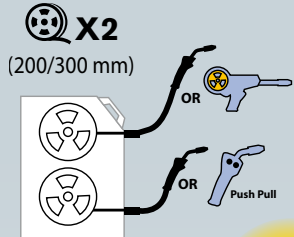

 MADE IN FRANCE	 EN60974-1	 50 / 60 Hz	 A	 Ø mm	 min → max	 FV TRI	 SPOOLGUN	 PUSHPULL	 200 300	Cooling system	 ELECTRONIC CONTROL	EN60974-1 (40°C)		 cm / kg	 Protected & compatible power generator (+/-15%)
												IA (60%)	X% (12 max)		
NEOPULSE 270-T1		400V · 3 ~	16	0,6 → 1,2	15 → 270	—	—	■ ■	Air	0,8 / 1,0 mm	190	270A@20%	38x52x64 / 37	12,5 kVA	
NEOPULSE 270-T2		230V · 3 ~	20	0,6 → 1,2	15 → 220	■	OPTION	■ ■	Air	0,8 / 1,0 mm	190	220 A @ 40%	38x52x64 / 39	10 kVA	
		400V · 3 ~	16		15 → 270						270 A @ 20%	12,5 kVA			
NEOPULSE 300		230V · 3 ~	20	0,6 → 1,2	15 → 240	■	—	OPTION	■ ■	Air	0,8 / 1,0 mm	220	240 A @ 60%	38x52x64 / 41	10 kVA
		400V · 3 ~	16		15 → 270							270 A @ 40%	12,5 kVA		
NEOPULSE 300-T2		230V · 3 ~	20	0,6 → 1,2	15 → 240	■	OPTION	OPTION	■ ■	Air	0,8 / 1,0 mm + 1/1.2 mm (Alu)	220	240 A @ 60%	84x103x63 / 72	10 kVA
		400V · 3 ~	16		15 → 270							270 A @ 40%	12,5 kVA		

PACKS PROMIG/NEOPULSE

PROMIG 350-4S



PROMIG 350-4S

- 4 m, 50 mm²
- Ø1/1.2 (original equipment)

 <p>Fe/CrNi 350 A, 4 m, air</p>	 <p>Alu 350 A, 3 m, air</p>
	 <p>Alu, Ø1/1.2 (x2)</p>

pack PROMIG 350-4S 1 035928	pack PROMIG 350-4S 2 035935
---------------------------------------	---------------------------------------

PROMIG 350 G.DV



TF-4R

PROMIG 350 G.DV

- 10 m, air, ø 70 mm²
- 4 m, 50 mm²
- Ø1/1.2 (original equipment TF-4R)

 <p>Fe/CrNi 350 A, 4 m, air</p>	 <p>Alu 350 A, 3 m, air</p>
	 <p>Alu, Ø1/1.2 (x2)</p>

pack PROMIG 350 G.DV 3 036109	pack PROMIG 350 G.DV 4 036116
---	---

PROMIG 350-4S DUO DV



PROMIG 350-4S DUO DV

- 4 m, 50 mm²
- Ø1/1.2 (original equipment)

 <p>Fe/CrNi 350 A, 4 m, air</p>	 <p>Alu 350 A, 3 m, air</p>	 <p>TF-4R</p>	 <p>10 m, air, ø 70 mm²</p>
	 <p>Alu, Ø1/1.2 (x2)</p>		
		 <p>Fe/CrNi 350 A, 4 m, air</p>	 <p>Alu 350 A, 3 m, air</p>
		 <p>Ø1/1.2 (original equipment TF-4R)</p>	 <p>Alu, Ø1/1.2 (x2)</p>

pack PROMIG 350-4S DUO DV 1 035966	pack PROMIG 350-4S DUO DV 2 035973	pack PROMIG 350-4S DUO DV 4 036123
--	--	--

NEOPULSE 270-T1 (Air Cooled)



NEOPULSE 270-T1



845 x 982 x 605 mm

- (x2) Ø0.8/1 (Original Equipment)
- 4 m, 35 mm²

 <p>Fe/CrNi 250 A, 3 m</p>	 <p>Alu 250 A, 3 m</p>
	 <p>Alu, Ø1/1.2 (x2)</p>

pack NEOPULSE 270-T1 A1 022478	pack NEOPULSE 270-T1 A2 022492
--	--

NEOPULSE 270-T1 (Water Cooled)



NEOPULSE 270-T1



WCT 1.3kW A
400V, 2~, 1300W, cooling unit (SI)

- (x2) Ø0.8/1 (Original Equipment)
- 4 m, 35 mm²

 <p>Fe/CrNi 300 A, 3 m, liquid</p>	 <p>Alu 300 A, 3 m, liquid</p>
	 <p>Alu, Ø1/1.2 (x2)</p>

pack NEOPULSE 270-T1 W1 022485	pack NEOPULSE 270-T1 W2 022508
--	--

NEOPULSE 270-T2 (Air Cooled)



NEOPULSE 270-T2



Cable support

845 x 982 x 605 mm

- (x2) Ø0.8/1 (Original Equipment)
- 4 m, 35 mm²

 <p>Fe/CrNi 250 A, 3 m</p>	 <p>Alu 250 A, 3 m</p>
	 <p>Alu, Ø1/1.2 (x2)</p>

pack NEOPULSE 270-T2 A1 032644	pack NEOPULSE 270-T2 A2 032651
--	--

NEOPULSE 270-T2 (Water Cooled)



NEOPULSE 270-T2



Cable support

WCT 1.3kW A
400V, 2~, 1300W, cooling unit (SI)

- (x2) Ø0.8/1 (Original Equipment)
- 4 m, 35 mm²

 <p>Fe/CrNi 300 A, 3 m, liquid</p>	 <p>Alu 300 A, 3 m, liquid</p>
	 <p>Alu, Ø1/1.2 (x2)</p>

pack NEOPULSE 270-T2 W1 032668	pack NEOPULSE 270-T2 W2 032675
--	--

SPOOLGUN

OPTION NEOPULSE 270-T2 & 300-T2

Torche motorisée Spool Gun - Spool Gun Torch
- Spool Gun Brenner

041486

Ideal Alu

Ø 0,8

&
· Acier / Steel / Stahl
· Inox / Stainless steel



PUSH PULL TORCH

OPTION NEOPULSE 270-T2, 300 & 300-T2

Motor inside

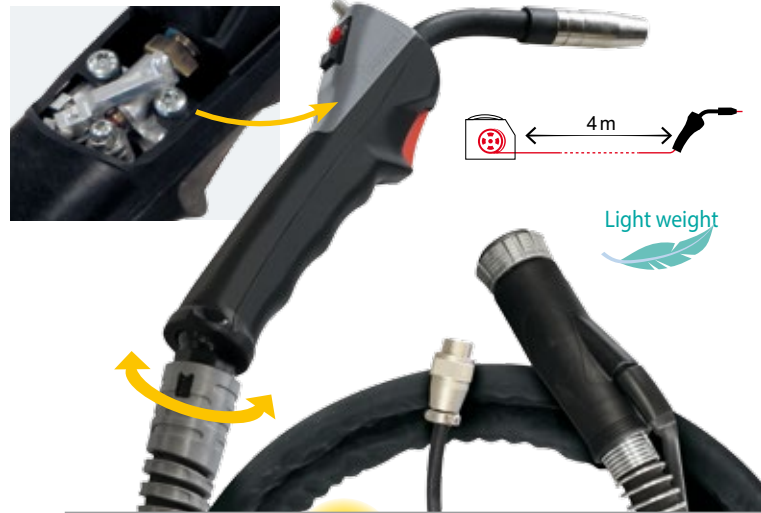

Ideal Alu MB15

Ø 0,8

160 A (40%)

Original equipment :
Ø 0,6/0,8-1,0
4 m, 2,9 kg

044111

Ideal Alu MB25

Ø 1,2

220 A (20%)

Original equipment :
Ø 0,8-1,0/1,2
4 m, 3 kg

046283

option Ø 0,6 / 0,8-1,0
046290

Welding Parameters access

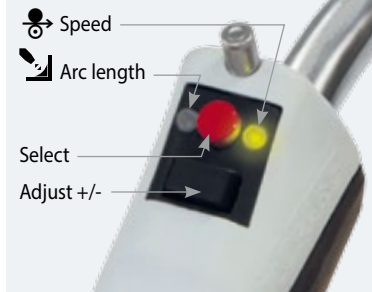

NEOPULSE 300 (Air Cooled)



NEOPULSE 300



Cable support



845 x 982 x 605 mm



(x2) Ø0.8/1
(Original Equipment)



4 m, 35 mm²



(x2) Ø1.0/1.2
Alu



4 m, 50 mm²



Fe/CrNi 250 A, 3 m



Alu 250 A, 3 m



Alu, Ø1/1.2 (x2)



Alu PUSH PULL, 220 A, 4 m

Ø 0.8 Alu Ø 1.0 Alu



Alu 250 A, 3 m

Ø 1.2 Alu

pack NEOPULSE
300 A1
032682

pack NEOPULSE
300 A2
032705

MERCEDES APPROVED
pack NEOPULSE
300 A3
022744

MERCEDES APPROVED
pack NEOPULSE
300 A4
022843

NEOPULSE 300 (Water Cooled)



NEOPULSE 300



Cable support



WCT 1.3kW A
4 00V, 2-, 1300W,
cooling unit (SI)



(x2) Ø0.8/1
(Original Equipment)



4 m, 35 mm²



Fe/CrNi 300 A, 3 m, liquid

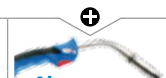

Alu 300 A, 3 m, liquid



Alu, Ø1/1.2 (x2)

pack NEOPULSE
300 W1
032699

pack NEOPULSE
300 W2
032712

NEOPULSE 300-T2 (Air Cooled)



NEOPULSE 300-T2



Cable support



Ø0.8/1 (2x2) + Alu, Ø1/1.2 (x2)
(Original Equipment)



4 m, 35 mm²



Fe/CrNi 250 A, 3 m



Alu PUSH PULL, 220 A, 4 m

Ø 0.8 Alu
Ø 1.0 Alu
Ø 1.2 Alu
(original equipment)

pack NEOPULSE
300-T2
022607

BOBINES DE FIL - Welding wire reels - Drahtrollen - Rollos de hilo - Draadbobijn - Bobines de fio

bobine écologique / ecological wire reel



	kg			Ø 0.6 mm	Ø 0.8 mm	Ø 1.0 mm	Ø 1.2 mm
Acier - Steel - Stahl - Acero - Staal - Aço (SG2)	0.9	100 mm	—	086593	086609		
	5	200 mm	—	086111	086128	086135	
	15	300 mm	—	086166	086227	086234	086241
	18	—	300 mm		086272 (15 kg)	086289	086296
	15	300 mm	—		086258		
Acier - Steel - Stahl - Acero - Staal - Aço (UHSS)	5	200 mm	—		086203		
Galva (G2Ti)	5	200 mm	—	086760	086777		
Alu (AlMg3)	2	200 mm	—				086517
	7	300 mm	—				086500
Alu (AlMg5)	0.5	100 mm	—		086548		
	2	200 mm	—		086555	086562	
	7	300 mm	—			086524	086531
Alu (AlSi5)	0.5	100 mm	—		086685		
	2	200 mm	—			086142	086159
Alu (AlSi12)	0.5	100 mm	—		086678		
	2	200 mm	—			086067	086074
Inox - Stainless - Edelstahl (308LSi)	1	100 mm	—		086616		
	5	200 mm	—		086579		
Inox - Stainless - Edelstahl (316LSi)	5	200 mm	—		086326		
CuSi3 HLE - UHTS (Boron Steel)	1	100 mm	—		086692		
	5	200 mm	—		086647	086654	
CuSi3 MIG Excellium	5	200 mm	—		086210		
CuAl8 HLE - UHTS (Boron Steel)	5	200 mm	—		086661	086197	
	15	300 mm	—			086180	
Fil fourré, Cored wire, Fülldraht, Hilo tubular Acier - Steel - Stahl NO GAS	4.5	200 mm	—		Ø 0.9 = 086623		086630
	0.9	100 mm	—		Ø 0.9 = 086104		
Rechargement Acier 60 HRC	16	—	300 mm				086173

NORMES - Norms - Normen - Norma		
AWS	EN	DIN
AWS 5.18 : ER 70S-6	EN ISO 14341-A : G46 4M G3Si1	DIN 8559 : SG2
AWS 5.28 : ER 90S-B3	EN ISO 21951-A : CrCrMo2Si	
AWS/ASME SFA-5.28 : ER 120 S-G	EN ISO 12534 : Mn4Ni2, 5CrMo	
AWS 5.18 : ER 70S-2	EN ISO 14341-A : G42 2 M G2Ti	DIN 8559 : SG2
AWS 5.10 : ER 5554	EN ISO 18273 : S Al 5554	DIN 1732 : SG-AlMg3
AWS 5.10 : ER 5356	EN ISO 18273 : S Al 5356	DIN 1732 : SG-AlMg5
AWS 5.10 : ER 4043	EN ISO 18273 : S Al 4043-A	DIN 1732 : SG-AlSi5
AWS 5.10 : ER 4047	EN ISO 18273 : S Al 4047	DIN 1732 : SG-AlSi12
AWS 5.9 : ER 308L Si	EN ISO 14343-A : G19 9 L Si	DIN 8556 : SG X2CrNi 19 9
AWS 5.9 : ER 316L Si	EN ISO 14343-A : G19 12 3 L Si	DIN 8556 : SG X2 CrNiMo 19 12
AWS 5.7 : ER CuSi-A	EN ISO 14640 : S Cu 6560	DIN 1733 : SG-CuSi3
AWS 5.7 : ER CuAl-A1	EN ISO 14640 : S Cu 6100	DIN 1733 : SG-CuAl8
AWS 5.20 : E71T-GS	EN ISO 17632-A T42 Z W N 1 H15	
	EN 14700 : TZ Fe 2	DIN 8555 : MSG 6-CF-60

ADAPTATEURS BOBINES - Adaptors for wire reels - Korbspulenadapter



ALIGNER 200
Ø 200
042889



ECO ADAPTER 300 Intensive
pour bobine écologique - for ecological wire reel - für Eco Fülldrahtrolle 043305



Professional
71608

After sales



Professional
71608

Press & Lock



Industrial
71613

Ø 200 & 300

GALETS - Rollers - Vorschubrollen - Rollen - Rodillos - Wielen - Roletes

		TYPE A	TYPE B	TYPE C
		Ø 30 mm	Ø 37 mm	Ø 37 mm
		Ø 9 mm	Ø 9 mm	Ø 19 mm
		Smartmig, Pearl, Multiplearl	Monogys, Trimig, Promig, Pearl XL, Multiplearl XL, TF 4R	Magys, Neopulse, W5S-4L, WS-4L/4R, Nomadfeed, Neofeed, Exafeed
Acier - Steel - Stahl - Acero - Staal - Aço - Inox - Stainless	Ø 0.6 / 0.8	(x1) 042339	(x1) 042087	(x2) 042353
	Ø 0.8 / 1.0	(x1) 041189	(x1) 042100	(x2) 042360
	Ø 1.0 / 1.2		(x1) 042179	(x2) 046849
	Ø 1.2 / 1.4			(x2) 039780
	Ø 1.2 / 1.6			(x2) 041752
Alu	Ø 0.8 / 1.0	(x1) 041196	(x1) 042155	(x2) 042377
	Ø 1.0 / 1.2		(x1) 042186	(x2) 040915
	Ø 1.2 / 1.6			(x2) 042391
Fil fourré - Corred wire	Ø 0.9 / 1.2	(x1) 042346	(x1) 042131	(x2) 042407
	Ø 1.2 / 1.4			(x2) 042124
	Ø 1.6 / 2.4			(x4) 047693

Fil fourré - Corred wire Ø 0.9 Smartmig 110 (Ø 25 mm) (x1) 044081

PINCE SPÉCIALE MIG/MAG ORIGINAL FIX - Special MIG/MAG plier - Spezial MIG/MAG Zange - Pinza especial MIG MAG



PRO (x1) 041332

1) Clean 2) Cut 3&4) Prepare (contact tube & nozzle)

KIT SOUDAGE NO GAZ Ø 0.9 - No Gas Welding Kit Ø 0.9

OEM : Universal 3P, Monomig 160-1, Pearl, Smartmig

041240

M6-Ø0,9 (x3)

Isolated Nozzle No Gas - 150 A (x1)

Ø 0,9 / 1,2 (x1)

COFFRETS - Boxes - Kästen - Cajas - Kistjes - Estojos

MB 15 (150 A) 041226	x3	x5	x3	
		x5 (M6-Ø0,6) x5 (M6-Ø0,8) x5 (Alu - M6-Ø0,8)		
MB 25 (250 A) 041233	x5	x3		
		x5 (M6-Ø0,8) x5 (M6-Ø1,0) x5 (Alu - M6-Ø1,0)		
MB 36 (350 A) 041417	x2	x3		
		x5 (M8-Ø1,0) x5 (M8-Ø1,2) x5 (Alu - M8-Ø1,0) x5 (Alu - M8-Ø1,2)		x2

SUPPORT TORCHE MAGNÉTIQUE - MIG torch stand with magnetic base

041653



TORCHES - Torches - Brenner - Antorcha - Lastoort - Tocha

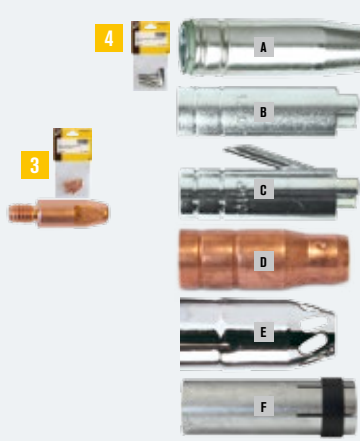
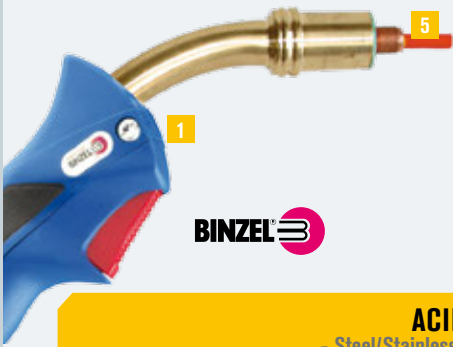

ACIER / INOX
- Steel/Stainless steel - Stahl/Edelstahl

ALU
- Aluminium - Aluminio

AIR

LIQUID

AIR

LIQUID

150 A

250 A

350 A

450 A

300 A

500 A

150 A

250 A

350 A

300 A

500 A

1 TORCHES COMPLÈTES - Complete Torches - Brenner - Antorcha - Lastoort - Tocha

	ACIER / INOX AIR				LIQUID		ALU AIR				LIQUID	
	150 A	250 A	350 A	450 A	300 A	500 A	150 A	250 A	350 A	300 A	500 A	
2	A	B	D	F	C	E	A	B	D	C	E	
3	M6	M6	M8	M8	M6	M8	M6	M6	M8	M6	M8	
Ø	Ø0.8	Ø1.0	Ø1.2	Ø1.2	Ø1.2	Ø1.2	Ø0.8	Ø1.0	Ø1.2	Ø1.2	Ø1.2	
X%	150A - 60%	200A - 60%	290A - 60%	450A - 60%	270A - 100%	380A - 100%	150A - 60%	200A - 60%	290A - 60%	270A - 100%	380A - 100%	
GRIP	GRIP	GRIP	GRIP	ABIMIG	GRIP	GRIP	GRIP	GRIP	GRIP	GRIP	GRIP	
L	3m	3m 4m	3m 4m	4m	3m 4m	4m	3m	3m 4m	3m 4m	3m 4m	3m 4m	
Ref.	041424 043268 043251	040700 040922 040540	040687 040946 040557	045392	040694 043275	041004 040564	041462	040724 040939	040731 040953	040748 043282	046160 041097	

2 SUPPORTS TUBE CONTACT & DIFFUSEURS - Tip adaptors & diffusers

	ACIER / INOX				LIQUID		ALU				
	150 A	250 A	350 A	450 A	300 A	500 A	150 A	250 A	350 A	300 A	500 A
	A1 (x5) 042902	B1 (x5) 042995	D1 (x3) 043008	F (x3) 045484	C1 (x3) 043589	E1 (x5) 042940	A1 (x5) 042902	B1 (x5) 042995	D1 (x3) 043008	C1 (x3) 043589	E1 (x5) 042940
	A2 (x10) 042988	B2 (x5) 042919	D2 (x5) 042926		C2 (x5) 043541	E2 (x3) 043022	A2 (x10) 042988	B2 (x5) 042919	D2 (x5) 042926	C2 (x5) 043541	E2 (x3) 043022

3 TUBES CONTACTS - Contact tips - Kontaktrohre - Tubo de contacto - Contactbuis - Pontas de contacto

	ACIER / INOX				LIQUID		ALU				
x10	150 A	250 A	350 A	450 A	300 A	500 A	150 A	250 A	350 A	300 A	500 A
Ø0.6	041905	041905			041905						
Ø0.8	041912	041950	041790	041790	041950	041790	041059	041059		041059	
Ø1.0	041929	041967	419803	419803	041967	419803	041066	041066	419766	041066	419766
Ø1.2	040144	041974	419810	419810	041974	419810	041073	041073	419773	041073	419773
Ø1.4			419827	419827		419827					
Ø1.6			419834	419834		419834			041080		041080
Ø2.4			040533	040533		040533					

4 BUSES - Gas nozzles - Düsen - Tubo - Nippel - Bicos

	150 A Ø12		250 A Ø15		350 A Ø16		450 A	300 A Ø17		500 A Ø16		150 A	250 A Ø15	350 A Ø16	300 A	500 A Ø16
Conique nozzle / Konische Düse	A (x3) 041875	E (x1) 043084	A (x3) 041882	E (x1) 040571	(x3) 041783	E (x1) 040588	A (x3) 045491	A (x3) 043534	A (x3) 042315	E (x1) 040588		Ø12 A (x3) 041875	A (x3) 041882	A (x3) 041783	Ø12 A (x3) 043534	A (x3) 042315
Pointage / Spitz / Welding / Punktdüse	B (x1) 041851											B (x1) Ø12 041851			Ø17 F (x3) 046221	
Soude clou / Nail welding / Nagel-schweißdüse	C (x1) 041523											F (x3) Ø16 046214				
Special No Gas (isolated)	D (x1) 041868															

5 GAINES - Torch liners - Mantel - Funda - Drahtseelen - Folha

	Acier - Steel - Stahl - Acero - Staal - Aço			Teflon		
Ø0.6x0.8	3 m		041592	Ø0.6 3 m		041578
	4 m		041837	Ø0.8 4 m		044050
Ø1.0x1.2	3 m		041608	Ø1.0x 3 m		041585
	4 m		041844	1.2 4 m		044067
Ø1.2x1.6	3 m		418417	Ø1.2x 1.6 4 m		044074
	4 m		418424			
Ø1.6x2.4	4 m		040526	Carbon		
				Ø0.6x 4 m		039834
				Ø0.8 4 m		039827
				1.2 4 m		039810

HELMETS

TEINTE
SHADE 9/13

EN 175-EN 379



LCD TECHNO 9/13
042544

LCD MASTER 9/13 G
040861

LCD PROMAX 9/13 G GOLD
045767



LCD HERMÈS SILVER
040908

LCD HERMÈS RED
040885

LCD HERMÈS GOLD
040892

**LCD ZEUS 5-9/9-13 G
FIRE**
044098

**LCD ZEUS 5-9/9-13 G
COSMIC**
044104

LCD AUTOMATIC TECHNOLOGY	BASIC		PRO			PRO+		EXPERT	
MODEL	TECHNO	MASTER	PROMAX	EXPERT	HERMES	ZEUS	ERGOTECH	GYSMATIC	
REF	042544	040861	(gold) 045767 (silver) 045774	(carbon) 040878 (blue) 042216	(silver) 040908 (red) 04088 (gold) 04089	(fire) 044098 (cosmic) 044104	(silver) 044173 (black) 045477	043909 046818	9/13 G 5/13 XL
	0.30 ms	0.30 ms	0.25 ms	0.30 ms	0.30 ms	0.20 ms	0.20 ms	0.08 ms	0.10 ms
	4 - 9 > 13	4 - 9 > 13	4 - 9 > 13	4 - 9 > 13	4 - 9 > 13	5 > 9 9 > 13	5 > 9 9 > 13	4 - 9 > 13	4 - 5 > 13
	1/2/1/1	1/2/1/2	1/1/1/2	1/1/1/2	1/1/1/3	1/1/1/2	1/1/1/2	1/1/1/2	1/2/1/1
MEMORY & REGULATIONS									ELECTRONIC
	92x42 mm	92x42 mm	100x49 mm	98x43 mm	98x43 mm	XL : 100x67 mm	XL : 100x67 mm	100x60 mm	XXL : 100x83 mm
	2	2	2	2	2	4	4 HIGH SENSITIVITY	4 HIGH SENSITIVITY	
		✓	✓	✓	✓	✓	✓	✓	
								✓	
							✓		
	☼	☼	☼	☼ + 2 (CR 2032)	☼ + 2 (CR 2032)	☼ + 2 (CR 2450)	☼ + 2 (CR 2450)	☼ + 2 (CR 2450)	☼ + 1 (CR 2450)
	Simple	Simple	Simple	Simple	Simple	Simple	Multi	Simple	
	440 g	450 g	385 g	510 g	510 g	515 g	560 g	450 g	460 g
BRAND MASK	<i>Toolit</i>	<i>Top Arc</i>	<i>Toolit</i>	<i>Toolit</i>	<i>Toolit</i>	<i>Toolit</i>	<i>Top Arc</i>	<i>Gys</i>	

VERRES - Lense - Schutzgläser

	110 x 90	x5	040816	116 x 89,5	x5	040779	226 x 106	x5	045781	111,2 x 91	x5	040793	111,2 x 91	x5	040793	114 x 133	x10	043893	114 x 133	x10	043893	114 x 133	x10	043893
	95,5 x 50,5	x5	040854	103,5 x 53	x5	040786	104 x 55	x5	040847	103,6 x 54	x5	040809	103,6 x 54	x5	040809	103,7 x 69,5	x5	043695	103,7 x 69,5	x5	043695	G: 106 x 66	x10	043886
																						XXL: 106 x 89,5	x10	046825



LARGE PROTECTION

LARGE PROTECTION

LCD PROMAX 9/13 G SILVER
045774

LCD EXPERT 9/13 G CARBON
040878

LCD EXPERT 9/13 G
042216

ERGOTECH 5-9/9-13 SILVER
044173

ERGOTECH 5-9/9-13 BLACK
045477



XXL VISION

MEMORY & REGULATIONS ELECTRONIC

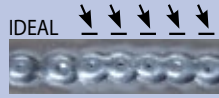

GYSMATIC 9/13 G
043909



GYSMATIC 5/13 XXL
046818



LARGE PROTECTION

LCD SPACEVIEW 5-9/9-13
040717

	EXPERT+	
SPACEVIEW	GYSMATIC AIR	NAVITEK
040717	047846	045842
0.10 ms	0.10 ms	0.20 ms
5>9 9>13	4 - 5>13	9>13
1/1/1/2	1/2/1/1	1/1/1/2
	ELECTRONIC	
XXL : 100x93 mm	XXL : 100x83 mm	93 mm
4 HIGH SENSITIVITY	4 HIGH SENSITIVITY	4 HIGH SENSITIVITY
✓	✓	✓
✓	✓	nc
☀ + 2 ̄ (CR 2032)	☀ + 1 ̄ (CR 2450)	☀ + 2 ̄ (CR 2330)
Multi	Simple	Simple
530 g	2.4 kg	1.6 kg
<i>Toolit</i>	<i>Gys</i>	<i>Gys</i>

GYSMATIC 5/13 AIR XXL
047846



Air 165 / 200 / 220 L/min



NEW 2016



Filtration class EN 12941 : TH2 P R SL

NAVITEK 9/13 +G VISOR
045842



Air 180 & 220 L/min

8>10h BATTERY LIFE



Visor (x5)
045828

Filter x10
045859

045866

Filtration class EN 12941 : TH2 P R SL

114 x 133	x10	043893	114 x 133	x10	043893	110 x 97	x10	045798
104 x 96	x5	043596	106 x 89,5	x10	046825	98 x 47	x10	045804

PLASMA CUTTER

1 Ø



Kompressor
INSIDE

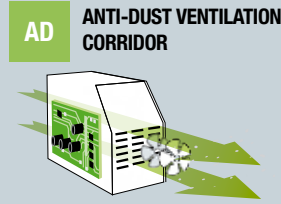
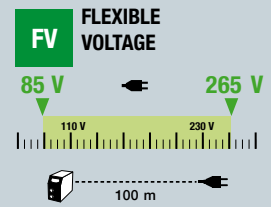
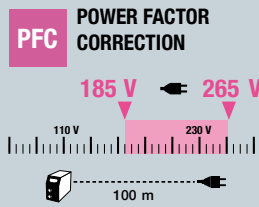

PATENTS REGISTERED NUMBERS EUROPEAN TRADEMARK & DESIGN

CUTTER 25 K

25 A ALU 4 mm INOX/STEEL 6 mm

20 A on 13 A fuse

CUTTER 35 KF

35 A ALU 8 mm INOX/STEEL 12 mm

PFC AD 30 A on 13 A fuse

CUTTER 31 FV

30 A ALU 8 mm INOX/STEEL 10 mm

PFC FV 30 A on 13 A fuse

CUTTER 40 FV

40 A ALU 10 mm INOX/STEEL 15 mm

PFC FV AD 30 A on 13 A fuse

with accessories : 030947

ERGOCUT S25K 4m+

with accessories : 031036

ERGOCUT S35K 4m+ 2m, 10mm²

with accessories : 030985

ERGOCUT S45 4m+

with accessories : 031043

ERGOCUT S45 4m+ 2m, 10mm²



CONSOMMABLES / CONSUMABLES

ERGO CUT	S 25K		S 35K		S 45	
	Qty	Part No.	Qty	Part No.	Qty	Part No.
	x4	040182	x1	040229	x4	040236
	x10	040151	x3	040212	x3	040212
	x2	040175	x1	040175	x1	040175
	x10	040168	x3	040168	x3	040168
Coffret - Box		039971		039964		039957

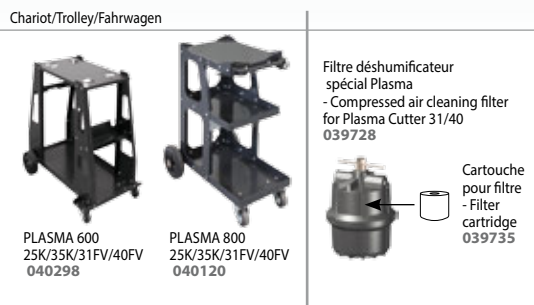

MADE IN FRANCE EN 60335/1	50/60 Hz	A	I ₂ A	mm				INTEGRATED TECHNOLOGY				AIR SYSTEM			EN 60974-1 (40°C)		cm	kg	Protected & compatible power generator (+/-15%)			
				Max Cut		Clean Cut		PFC	FV	AD	KOMPRESSOR INSIDE	mini	ideal	maxi	IA 60%	X%12 max						
CUTTER 25K 030947	230V 1~	16	5 → 25	6	4	4	3	—	—	—	■	—	—	—	—	—	12	26	22 x 45 x 31	17,2	4,1 kW	5,9 kVA
CUTTER 35KF 031036	230V 1~	16	10 → 35	12	8	8	6	■	—	■	■	■	—	—	—	—	28	30	28 x 52 x 46	30	8 kW	10 kVA
CUTTER 31FV 030985	230V 1~	16	5 → 30	10	8	7	5	■	■	—	—	■	2,5 bar	4,5 bar 115l/mm	9 bar	22	32	19 x 44 x 28	12	6 kW	7,5 kVA	
	110V 1~	32	5 → 30													19	25					
CUTTER 40FV 031043	230V 1~	32	10 → 40	15	10	10	8	■	■	■	—	■	2,5 bar	4,5 bar 115l/mm	9 bar	32	40	21 x 51 x 37	20	8 kW	10 kVA	
	110V 1~	32	10 → 30													25	40					



INDUCTION HEATING

1 Φ or 3 Φ



POWERDUCTION 50LG

5 200 W

PFC

no accessories :
055599



NEW

POWERDUCTION 160L

16 000 W

no accessories :
053472



OPTIONS



Potence - Cable support
Powerduction 50L only
052284



Colle-Stick bi-composant Power Epoxy 150°C
054851

Model	Option 1	Option 2	Option 3	Label
50LG	20° 056862	053823	056909	NEW
	90° 056879	053823	056909	NEW
	056886	053458	056916	NEW
160L	053748	053755	054844	

CE NORM 60974/1	⚡	⚡-AM	⚡	Freq.	INTEGRATED TECHNOLOGY	❄️	Cable L (m)	↕	👤	
	Hz	A	W	kHz		Liquid Cooling	Inductor	cm	kg	
POWERDUCTION 50LG	230V, 1~50/60 Hz	25 mini	5200	30→50	—	—	8	3	88 x 59 x 59	65
POWERDUCTION 160L	400V, 3~50 Hz	24 mini	16000	15	—	—	10	4	120 x 60 x 50	190





GYSDUCTION AUTO

2 400 W

PFC FV

COMPLETE



Décapage
- Glass
- Entfernen
053373



Décollage
- Decal
- Entkleben
053359



Dégrippage
- Bolt heating
- Lösen
053366



Protection (x5)
+ Colle - Stick
053854



Protection (x10)
+ Colle - Stick
053847

OPTION

Spray refroidisseur
- Freezer spray
-50 °C
400 ml
(x 12)
048898



Adhesive for logo
(x10)
051492

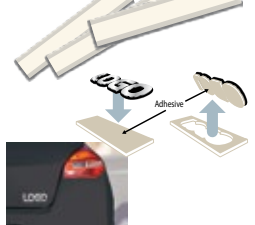

055490

NEW
09-2017

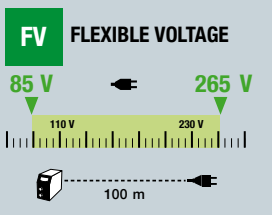
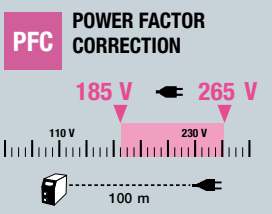

Débosselage rapide et sans peinture
- Fast and paintless dent pulling
- Lackschadentreies Ausbeulen
054776



3 m

NEW
09-2017 Update kit for Gysduction Auto < 05/2015 597251



1,2 kW

Inducteur spirale
- Spiral inductor
- Spiralinduktor
054783

INCLUDED

Spirale - Coil - Spiralförmiger draht	
	Ø 18 mm 054806
	Ø 24 mm 054790
	Ø 30 mm 055469
Fil tressé enroulable - Flexible wrappable wire - Flexibel geflochtener draht	800 mm 054813
Fil droit rigide - Straight rigid wire - Steif gerade draht	800 mm 054868

				Freq. kHz	INTEGRATED TECHNOLOGY		Liquid Cooling	Cable L (m)		cm	kg
					PFC	FV		Inductor	Inductor		
GYSDUCTION AUTO	50/60 Hz	A	W	35 ±120	■	■	—	2	2,5	22 x 36 x 27	7,2

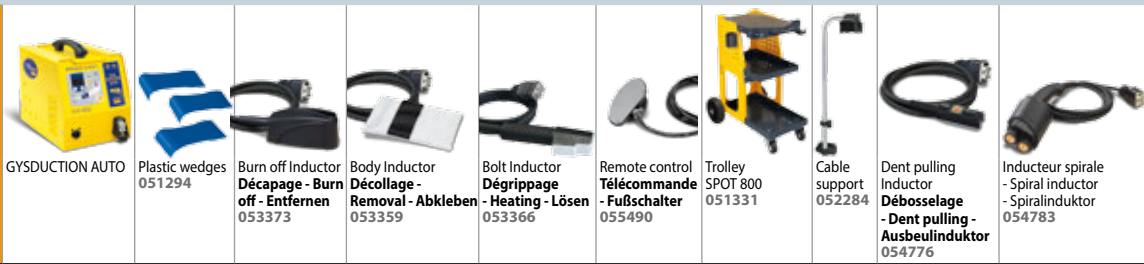
PACKS GYSDUCTION AUTO
GYSDUCTION AUTO

	GYSDUCTION AUTO	Plastic wedges 051294	Burn off Inductor Décapage - Burn off - Entfernen 053373	Body Inductor Décollage - Removal - Abkleben 053359	Bolt Inductor Dégrippage - Heating - Lösen 053366	Remote control Télécommande - Fußschalter 055490	Trolley SPOT 800 051331	Cable support 052284	Dent pulling Inductor Débosselage - Dent pulling - Ausbeulinductor 054776	Inducteur spirale - Spiral inductor - Spiralinductor 054783
PROLINER AUTO 048775	☉ ■	■	■	■	■	■	■	■		
COMPLETE AUTO 053380	☉ ■	■	■	■	■	■				
NEW COMPLETE AUTO + 056978	☉ ■	■	■	■	■	■	■	■	■	■
MECA AUTO 048812	☉ ■	—	—	—	■	■				
NEW MECA AUTO + 056961	☉ ■	—	—	—	■	■	—	—	—	■
BODY SHOP AUTO 048799	☉ ■	■	■	■	—	■	—	—	■	
GLASS AUTO 048805	☉ ■	■	■							
DENT REPAIR AUTO 054981	☉ ■	—	—	—	—	—	—	—	■	

HAND-DUCTION HEATING SYSTEM

NEW 2017

with accessories ◀ EUR • 230 V :
056923

UK : 057371 (230V)
US : 057395 (110V)
AU : 057388 (230V)

L : 37cm • Ø : 8.2 cm • 2,54kg • 5A
40-80 KHz • 1200w

Ergonomique et léger
- Lightweight and ergonomic
design

Éclairage LED
- Light LED

**MADE IN
HIGH
QUALITY
USA**

Refroidi air
- Air cooled

Verrouillage facile des inducteurs
- Coil Twist Lock

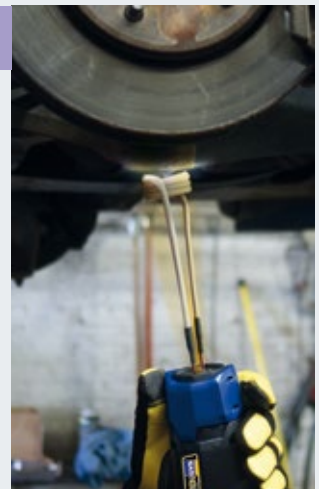

Spirale - Coil - Spiralförmiger draht	Fil tressé enroulable - Flexible wrappable wire - Flexibel geflochtener draht	Fil droit rigide - Straight rigid wire - Steif gerade draht
22mm (7/8 in.)	1m (41 in.)	584mm (23 in.)

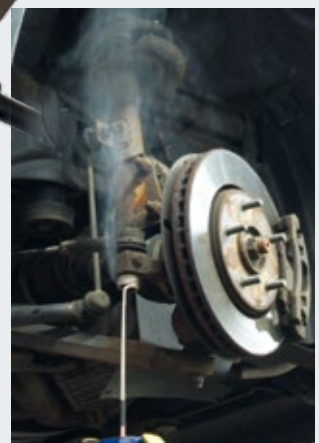

SYSTÈME DE DÉCOUPE PARE-BRISE A CLIQUET
- Windshield Cutting kit - Kit zum Lösen von Windschutzscheiben

054738



KIT DÉCOUPE JOINT DE PARE-BRISE - Windscreen Joint-cutting Kit - Scheibentrenn-Werkzeug-Set

051898



OUTIL DÉCOUPE PARE-BRISE - Windshield Cutting Tool - Windschutzscheiben-Ausglas-Set

051935



PROTECTIONS TABLEAU DE BORD - Dashboard Protector - Armaturenbrett Schutz

053120



KIT VENTOUSE ET SANGLE - Suction Cup and Strap Kit - Saugnapfheber

051966



RÉPARATION PARE-CHOC - Bumper repair - Reparatur von Stoßstangen

AGRAFEUSE POUR RÉPARATION PARE-CHOC - Hot stapler for bumper repair - Stoßstangen Reparatur Kit



PORTABLE
Sur batterie - Battery operated

MADE IN TAIWAN



Agrafes - staples



		Ø 0,6 mm	Ø 0,6 mm	Ø 0,8 mm	Ø 0,8 mm	Ø 0,8 mm
052413	=	x 50	+	x 50	+	x 50

Agrafes - Staples

V	U	N	W	M
Angle interne étroit - Inside corner Ø 0,7 mm	Alignement de fissure - Crack alignment Ø 0,7 mm	Fissure importante - Large crack Ø 0,7 mm	Angle interne - Internal angle Ø 0,7 mm	Angle externe - External angle Ø 0,7 mm
x 100 047990	x 100 047983	x 100 047976	x 100 047969	x 100 047952

COFFRET DE RÉPARATION DES PLASTIQUES AUTOMOBILES - Brazing automotive plastics repair kit - Kunststoff Reparatur Kit



Spray refroidisseur
- Freezer spray
-50 °C
400 ml

(x 12)
048898



GYS HAND TOOLS - Ausbeulwerkzeug



OUTIL DE POINÇONNAGE OBLONGS
- Oval hole punch - Langlochkarosserieblechzange

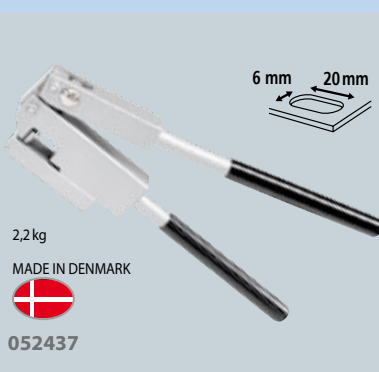

REDRESSEUR DE CHARNIÈRE DE PORTE

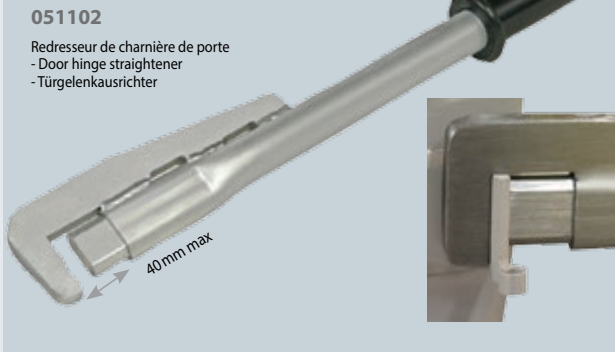

OUTILS DE FORME - Forming tools - Formgebungswerkzeuge



JEU DE 4 BURINS EN NYLON
- Set of 4 nylon chisels - 4 Kunststoffmeißel

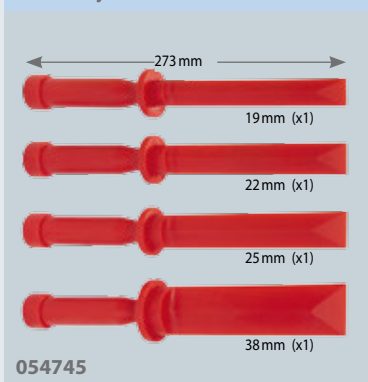

PINCES DE MAINTIEN BORD À BORD - Positioning clamp - I-Stoß-Lehre



JAUGES DE PROFIL - Contour Gauge - Kontourenlehre



JAUGES DE POSITIONNEMENT - Gapping gauges - Spaltmaßlehre



MINI VENTOUSE - Handheld suction lifter

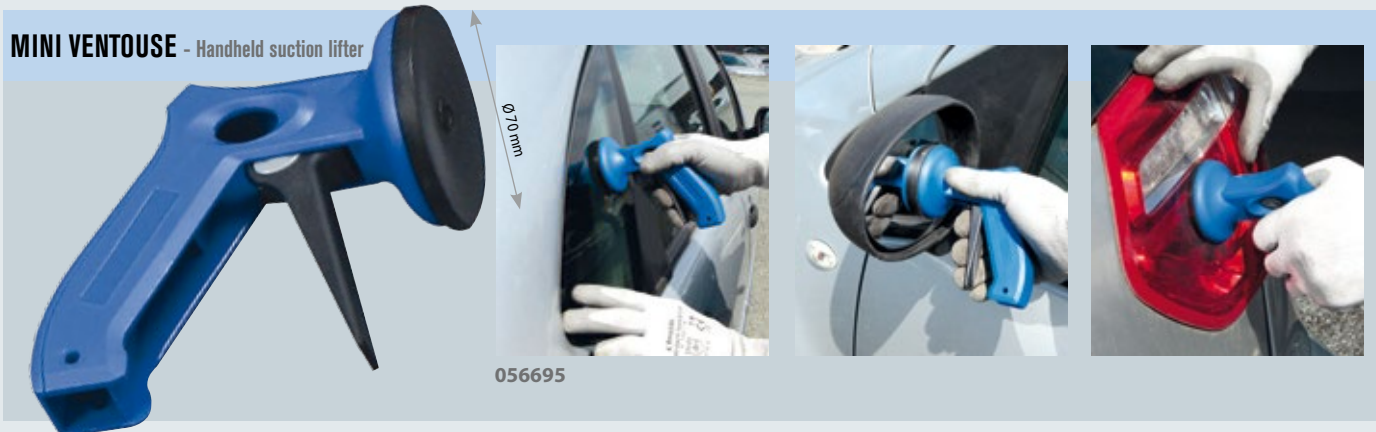

PINCES - Clamps - Fixier-Klemmen



OUTIL DE REMISE EN FORME PASSAGE DE ROUE - Fender roller tool set

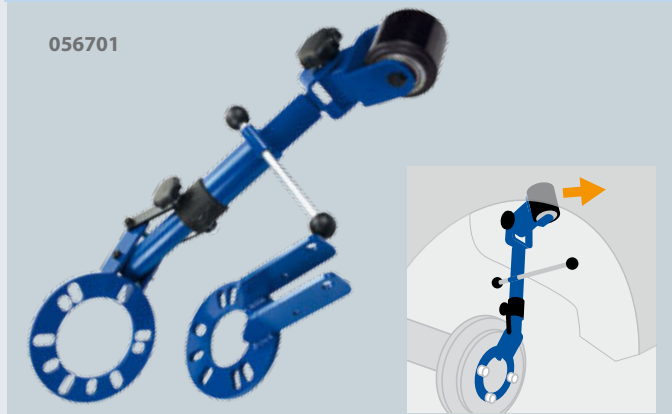

EASYPULLER (CARE & MAINTENANCE)



COFFRET DÉCAPEUSE PNEUMATIQUE - Pneumatic surface remover Kit - Drucklufttroster-Box inkl. Zubehör

051775



Roue gomme
115 x 14 mm
051874



Roue à découper
115 x 14 mm
051843



Adaptateur
pour brosse
051768



Brosse souple
103 x 23 mm
052598



Brosse dure
103 x 23 mm
051812



Brosse souple
103 x 23 mm
051850

Speed rpm	Power W	dB	Air consumption l/min	Air pressure bar	↔ cm	kg
4000	500	86	102	6,2	280	1,2

PONCEUSE À BANDE - Air belt sander - Druckluft Bandschleifer

052819

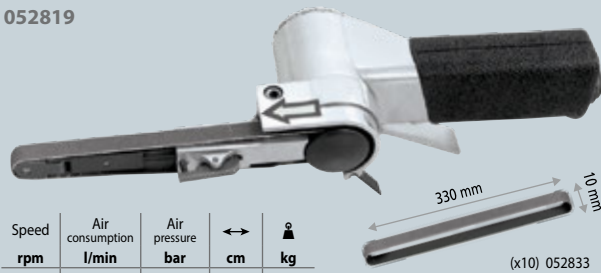

Speed rpm	Air consumption l/min	Air pressure bar	↔ cm	kg
16000	171	6,3	26	0,9

(x10) 052833

PERCEUSE MANDRIN AUTOMATIQUE

- Automatic Mandrel Drill
- Druckluftbohrmaschine
m. Schnellspannfutter

051799

Ø 13



Speed rpm	Power W	dB	Air consumption l/min	Air pressure bar	↔ cm	kg
800	300	92	170	6,2	18	0,9

MINI-MEULEUSE - Mini disc sander - Druckluftschleifer



051829



Ø 75

Speed rpm	Power W	dB	Air consumption l/min	Air pressure bar	↔ cm	kg
18000	200	83	171	6,2	12	0,7

Included
(x1)
052468

SCIE COUPE TÔLE DROITE ET LIME - Saw for Straight Cut and File

- Druckluftsäge und Feile



051805

(x5)
052789

Speed rpm	Power W	dB	Air consumption l/min	Air pressure bar	↔ cm	kg
5000	—	85	255	6,2	10	0,8

MINI-MEULEUSE À RENVOI D'ANGLE - Mini Angle Grinder

- Mini-Druckluftwinkelschleifer geräuschgedämpft

051867



Speed rpm	Power W	dB	Air consumption l/min	Air pressure bar	↔ cm	kg
15000	200	86	85	6,2	18	0,75

(x1) 052772

MINI-FRAISEUSE À RENVOI D'ANGLE

- Mini Angle Milling Machine - Mini-Winkelschleifer

051836



Speed rpm	Power W	dB	Air consumption l/min	Air pressure bar	↔ cm	kg
18000	500	81	85	6,2	18	0,7



PINCE À SOYER ET À TROUER, Ø5MM PNEUMATIQUE - Pneumatic flange / ø5 mm punching tool - Pneumatische Loch- und Absetzange Ø 5 mm

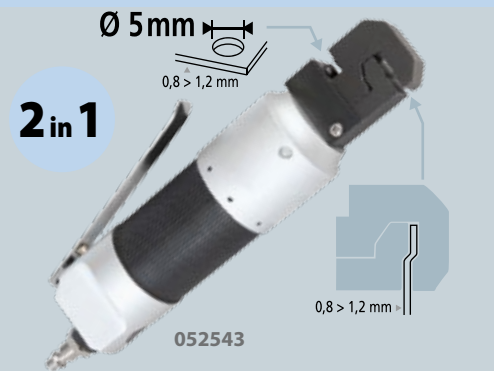

POINÇONNEUSE PNEUMATIQUE OBLONG

- Pneumatic oval punching tool
- Pneumatische Langloch-Blechzange

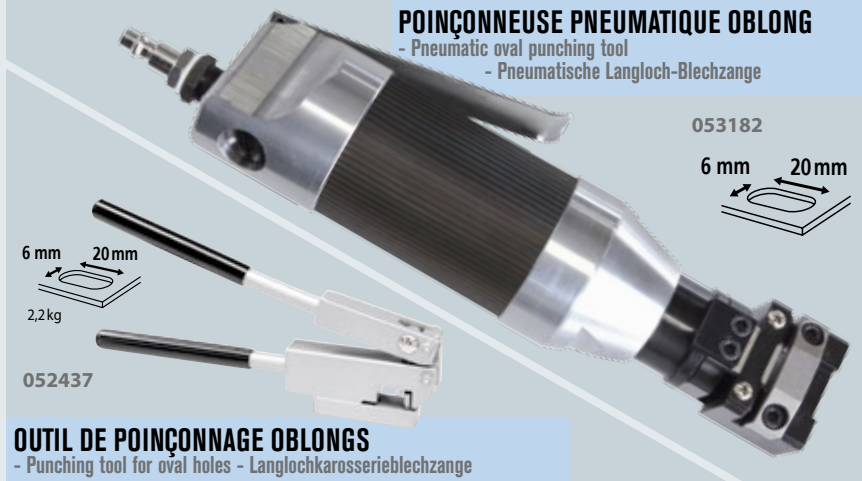

OUTIL DE POINÇONNAGE OBLONGS

- Punching tool for oval holes - Langlochkarosserieblechzange

DÉPOINTEUSES - Spot remover - Druckluft-Schweißpunktbohrer

Foires de dépointage
- Spot remover drill
- Schweißpunktfräse

Tungsten Carbide for BORON/UHSS

Ø 8 mm 053069

Ø 10 mm 053076

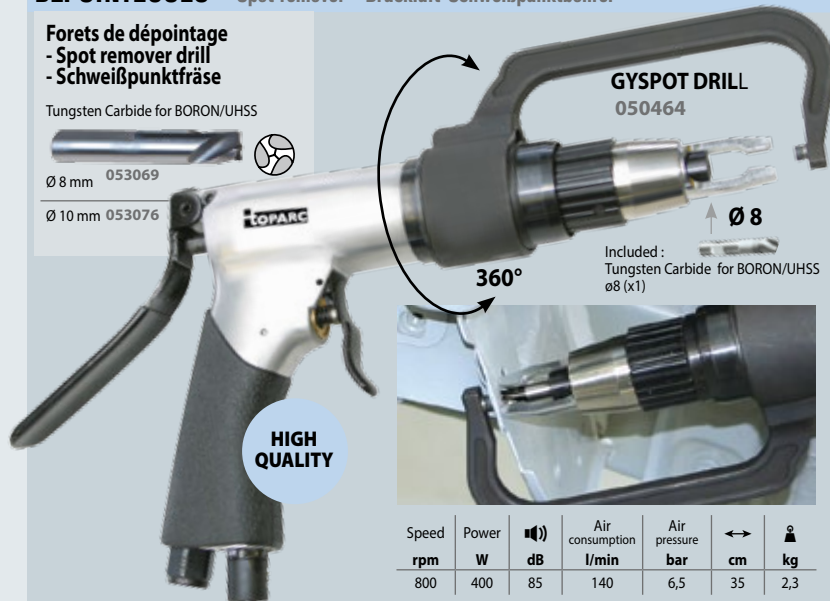

Speed	Power	dB	Air consumption	Air pressure	cm	kg
rpm	W		l/min	bar		
800	400	85	140	6,5	35	2,3

BODY ZIPPER - Sertisseuse pneumatique
Pneumatic Crimper - Druckluftkantenformer

056930



Air pressure	cm	kg
bar		
5	28	2,1

MADE IN HIGH QUALITY POLAND

DÉPOINTEUSE POUR CORDON LASER ACIER & ALU - Laser cord metal sheet cutter (nibbler) - Trennwerkzeug für Lasernähte



DÉPOINTEUSE POUR CORDON LASER

- Laser cord metal sheet cutter (nibbler) - Trennwerkzeug für Lasernähte



RENOV'POLYCARBONATE - Compressed air polisher - Druckluftpolierer





TRÉTEAUX - Frames support - Klappböcke

040601
100,5 x 112 cm - 5,5 kg
35 x 95 x 106 cm



Ø28 mm
4 pieds coudés
Idéal sur caillébotis
- Bent feet for grating
- Abgewinkelte Standfüße:
Sicherer Stand auf Gittern u.ä.

040311
104,5 x 117 cm - 8,1 kg
32 x 10 x 106 cm



Ø32 mm

040250
100 x 105 cm - 7 kg
32 x 10 x 106 cm



Ø32 mm



040304
104,5 x 108,8 cm - 8,1 kg
32 x 10 x 106 cm

Léger et très maniable
Spécial travaux à l'horizontal
- Light and easy to handle
Ideal for horizontal works
- Speziell geeignet für Arbeiten
in horizontaler Position



Chainette réglable
- Adjustable catenary



Mousse de protection
- Protecting foam

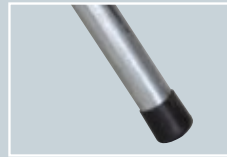

Antidérapants
- Non-slip base



4 ventouses
Dépose vitrages
- Suction pad for glazing
- Gummiteiler zur Fixierung
von Glasscheiben

SUPPORT ÉLÉMENT ROTATIF
- Rotary element support - Lackierständer für Stoßstange, einstellbar

052611
200 x 101 cm - 17,5 kg
35 x 15 x 110 cm
Made in China

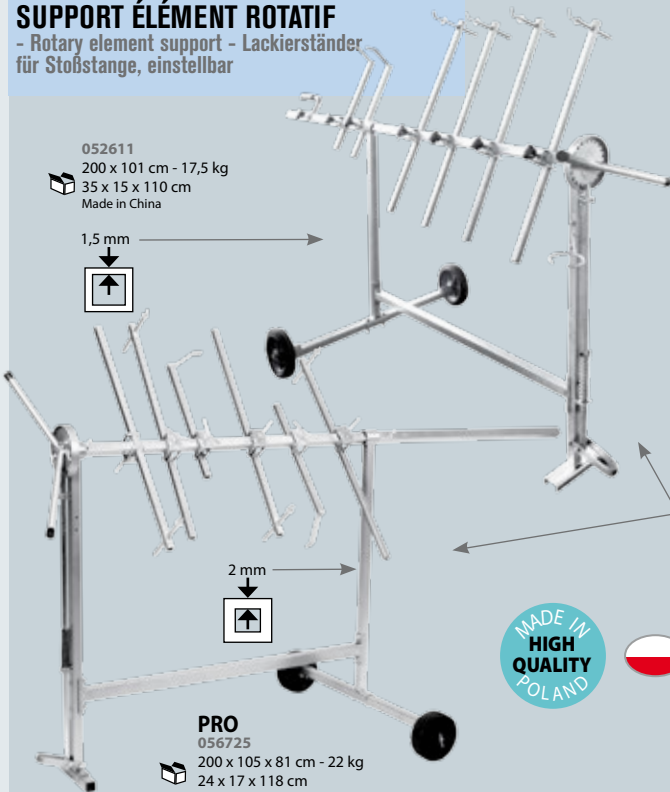

1,5 mm

2 mm

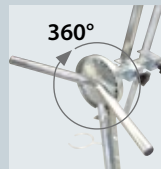

Verrouillage de l'axe
- Locking of the axis
- Verriegelung der Achse



PRO
056725
200 x 105 x 81 cm - 22 kg
24 x 17 x 118 cm

SUPPORT PARE-CHOC - Rotary element support - Lackierständer für Stoßstange, einstellbar

052376
91 x 105 cm - 7,6 kg
60 x 11 x 75 cm



Adapté aux coques de rétroviseurs
- Adapted to wing mirror covers
- Geeignet für Außenspiegel

TIGES DE BLOCAGE
- Flap Lock

NEW

056732

30 > 115 cm

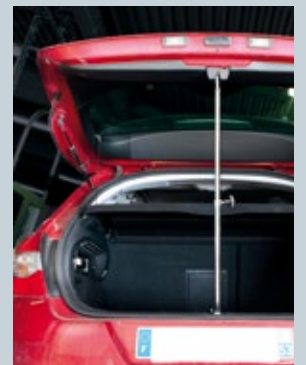



CHARIOT DE LUXE MAROUFLAGE - Premium masking machine

057333
150 x 133 x 62 cm
- 32 kg
152 x 17 x 29 cm

MADE IN
HIGH
QUALITY
POLAND



x 5
rouleaux de papier
- Papierständer
- Paper roll
30 > 120 cm



NEW
09-2017

CHARIOT DE MAROUFLAGE - masking machine

056954
150 x 62 x 110 cm - 12 kg
122 x 29 x 17 cm

MADE IN
HIGH
QUALITY
POLAND



x 3
rouleaux de papier
- Papierständer
- Paper roll
30, 60, 90 cm

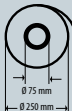

NEW
09-2017

CHARIOT DE STOCKAGE - Storage trolley - Lagerrollwagen

040243
71 x 90 x 197cm - 41 kg
x2: 91 x 147 x 6 cm
+ 69 x 93 x 44 cm



COLOR MATCH



Daylight lighting
for perfect colour recognition

MATCHPEN

4000 K, 300-4000 lux
100 lumen
10°-70° beam angle
IP 54
2x AAA 1,5V
055605

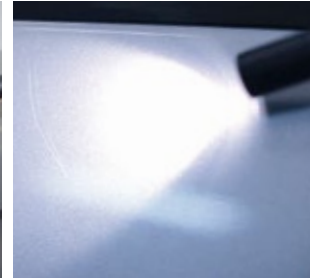

SUNMATCH

4500 K, 1100-550 lux (step 1-step 2)
400-180 lumen (step 1-step 2)
IP 65
1h/3h operation time
3,7 V - 2200 mAh Li-Ion battery
055612

055940
055919



MULTIMATCH

4500 K, 3500-1400 lux (step 1-step 2)
2000-600 lumen (step 1-step 2)
IP 67
1h/6h operating time
11,1 V - 4400 mAh Li-Ion battery
055629

055957
055926



COLOUR MATCH KIT =
MATCHPEN + SUNMATCH + MULTIMATCH
055636

055964
055933



Discover it
on Youtube



COUVERTURE ANTI-CHALEUR - Heat cover - Hitzeschutzdecke - Manta anti-calor - Protecção anti-aquecimento



PROTEC 550
550°C/1000°F - Class M0
2 m x 2 m - 580 g/m²
050495



PROTEC 1200
1200°C/2200°F - Class M0
1.75 m x 1.5 m - 1200 g/m²
050204



PROTEC 1300
1300°C/2400°F - Class M0
XL: 2 m x 1.8 m - 620 g/m²
053595



PROTEC 1300L
1300°C/2400°F
XL: 2 m x 1.8 m - 427 g/m²
060500

JEU DE 2 AIMANTS
- Set of 2 magnets -
Schweißmagnet

(x2)
052291



LUNETTES DE PROTECTION - Protection goggles - Schutzbrillen

Antiprojection/meulage - Anti-projection/grinding - Anti-proyección/amoladura - Spritzschutz/Schleifen



Shade/RS
042841



Shade/RO
042865



Shade/RO
047778



Shade/RO
047792

RIDEAU DE SOUDAGE

- Welding curtain and frame - Schweißerschutzwand



OPTI 215.O
Orange CE - 2 x 2.15 m
EN 25980 - 2015/01
060470



OPTI 200G
Green T9 - 2 x 2 m
EN 25980 - 2015/01
060463

GANTS - Gloves - Handschuhe - Guantes



Heavy Duty T10
(MMA - MIG - Plasma)
045101



Gants de soudage
Renforcés - Reinforced
welding gloves: T10
045873



Gants Manutention
Anti coupe - Anti-cut handling
gloves: EN388:4343
T9: 045897



Anti coupe haute résistance
High resistance anti-cut handling
gloves: EN 420 - EN 388:3131
T9: 045910
T10: 045927



Anti coupe haute dextérité
High precision anti-cut handling
gloves: EN 420 - EN 388:3111
T9: 045903
T10: 045934

VESTE - Jacket - Jacke



98% cotton, 2% antistatic
S (40/42) 046313
M (44/46) 046320
L (48/50) 046337
XL (52/54) 046344
XXL (56/58) 046351

PANTALON - Trousers - Hose



98% cotton,
2% antistatic
S (40/42) 046368
M (44/46) 046399
L (48/50) 046382
XL (52/54) 046399
XXL (56/58) 046412

TABLIER CUIR MULTI-USAGE

- Multi-use leather apron
- Delantal de cuero multi-uso -
Mehrzweck-Lederschürze



PRO
045217

MANCHETTES DE SOUDEUR

- Welding sleeves - Schweißärmel
- Mangas protectoras

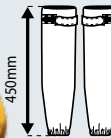

045231

CAGOULE TEXTILE DE PROTECTION

- Fireproof protection
hood - Textil-Schweiß-
schutzhaube - Máscara
de protección



045224

ASPIRATEURS DE FUMÉE - Fume Extraction Systems - Rauchgasabsauggerät

• 230V / 1 ~ / 50 Hz
• 1100 W
• 200 m³/h max
• 190 mbar max
• 26 kg / 390 x 210 x 500 mm
• 71 db
• Système de nettoyage automatique du filtre

Automatic ON/OFF 043237
Manual 043244

150 A, 3m, Grip 043251

+ = 100 m³/h

• 230V / 1 ~ / 50 Hz
• 2 x 1000 W
• AUTOMATIC ON/OFF

2.5 m (included)

OPTIONS

039889 5 m (included) 040656

039872 040649 (included)

Filter - Filter 039865

EVO 2.1

• 230V / 1 ~ / 50 Hz - 32A
• 1100 W
• 1200 m³/h max
• arm 3 m
• included
• 85 kg

046474

Breveté - Patented
Welding detection
Automatic ON/OFF

230 V connection

792 mm

347 mm

Filter - Filter (included) 046498

UNI 2.0

• 400V / 3 ~ / 50 Hz
• 1100 W
• 1300 m³/h max
• arm 3 m
• no plug
• 100 kg

046443

Filter - Filter (included) 046467

BATTERY SUPPORT UNIT (BSU)

BATTERY CHARGER



MADE IN FRANCE



10,5 cm



GYSFLASH 30.12 HF		PFC
30 A	12 V	

029224

GYSFLASH 30.24 HF		PFC
30 A	6/12/24V	

029231



GYSFLASH 40.12 FV		PFC
40 A	12 V	FV

029064



GYSFLASH 50.12 HF		PFC
50 A	12 V	

1 044 40004

029088

GYSFLASH 50.24 HF		PFC
50 A	6/12/24V	

029095



GYSFLASH 100.12 HF		PFC
100 A	12 V	

029071

CHARGE

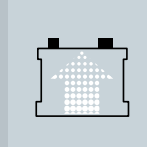

DIAG +

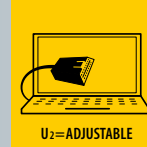

SHOWROOM

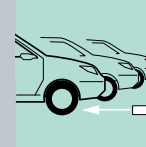

 CONNECTOR
SHOWROOM Ø M6

AUTO DETECT

MICRO-PROCESSOR CONTROL

Protection for on-board electronics

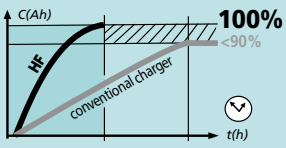
TECHNOLOGY & ADVANTAGES



100%

50% de gain de temps + batterie chargée à 100%

50% of time saved + battery 100% charged

50% Zeitersparnis + 100% Vollladung

ahorro de tiempo de 50% + batería cargada a los 100%

HIGH EFFICIENCY

Up to 15% Energy Saving

93%

EMC class B

PFC POWER FACTOR CORRECTION

185V

265V

100m

EASY MODE

FAN LESS TECHNOLOGY

SULPHATED BATTERIES

AUTOMATIC RECOVERY

Option 5m 054615

Tablette - Wall support - Halterung

055513

MEMORY SAVER

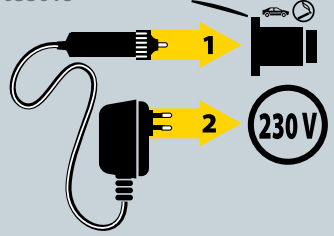
 230V/12V
055018

PROTECTION ANTI-ARC 12V

- Anti-arc protection 12V - Lichtbogenschutz 12V - Protección anti-arco 12V

041318



A COMPLETE RANGE

for 200 > 240 V MONO / TRI
50/60 Hz

DÉBOSSELAGE - Dent pulling - デントプラー

GYSPT 2600

page 6



GYSPT 2700

page 6



GYSPT 39.02

page 7



GYSPT PRO 230

page 7



GYSPT ALU PRO FV

page 8



GYSPT COMBI 230 PRO

page 9



SOUDURE PAR POINT - Spotwelding - スポット溶接

GYSPT BP.LCX-s7 220 V

page 38



GYSPT EVOLUTION PTI-s7 220 V

page 39



RIVETAGE - Riveting - リベット打ち

GYSRESS 8t

page 43



CHARGEUR DE BATTERIE - Battery charger - バッテリーチャージャー

GYSFLASH 40.12 FV

page 69



DÉCOUPAGE PLASMA - Plasma cutting - プラズマカッター

CUTTER 31 FV

page 58



CUTTER 40 FV

page 58



INDUCTION - インダクション

GYSDUCTION AUTO

page 60



MIG/MAG TRADITIONNEL - Traditional MIG/MAG - ミガマガトラディショナル

M1GYS AUTO

page 46

M3GYS AUTO

page 47

T1GYS AUTO DV

page 46

T3GYS AUTO DV

page 47

PROMIG 350 G.DV

page 49

PROMIG 350-4S DUO.DV

page 49



MIG/MAG INVERTER - ミガマガインバーター

MIG/MAG INVERTER PULSÉ - ミガマガパルスインバーター

Multi PEARL 200-2

page 48

Multi PEARL 200-4 XL

page 48

Multi PEARL 201-4

page 48

NEOPULSE 270-T2

page 50

NEOPULSE 300

page 51

NEOPULSE 300-T2

page 51



INDIAN CAR MANUFACTURER APPROVALS / COMPLIANCE



		OEM - CARS										OEM - TRUCKS						
DENT PULLER	GYSPT 39.02																	
	SPEEDLINER																	
	GYSPT ALU FV																	
SPOT WELDERS	GYSPT 32D																	
	GYSPT INVERTER BP-MS/LX/LC/LQC	•	•	•	•	•	•	•	•	•	•	•	•	•	•	•	•	•
	GYSPT EVOLUTION PTI-s7																	
MIG / MAG	T1 GYS AUTO	•	•	•	•	•	•	•	•	•	•	•	•	•	•	•	•	•
	T3 GYS AUTO																	
	NEOPULSE	•																
PLASMA	CUTTER 25K																	
	CUTTER 31FV																	
INDUC-TION	GYSDUCTION AUTO																	
BATTERY CHARGERS		•																
TOOLS & TROLLEYS		•																



Formations agréées
Ref. 52.53.0068153

Centre de formation agréé
Training centre dedicated to professionals
Trainingcenter für Profis

France

BP 4159
53941 Saint-Berthevin
ZI, 134 bd des Loges
Laval
France
Fax : (+33) 2 43 68 35 21

www.gys.fr
E-mail : contact@gys.fr

Germany

Professor-Wieler-Straße 11
52070 Aachen
Deutschland
Tel : (+49) 241 / 189-23-710
Fax: (+49) 241 / 189-23-719
www.gys-schweissen.com
E-mail : aachen@gys.fr

UK

Unit 3
Great Central Way
Rugby - Warwickshire - CV21 3XH
United Kingdom
Tel : (+44) 1926 338 609
Fax: (+44) 1926 429 764
www.gys-welding.com
E-mail : uk@gys.fr

Italia

C.P. 158 - Mestre Centro
30171 Mestre-Venezia
Italia
Tel : (+39) 340 3677916
Email : italia@gys.fr

India

796/1A-A, Avinashi road
opp to Decathlon
Neelambur, Coimbatore
641062 Tamil Nadu
India
Tel : +91. 88708. 71111
E-mail : s.kumar@gys.fr

China

Lot N°15
6666 bd Songze
201706 Qingpu Shanghai
China
Tel : (+86) 6221 4461
Fax : (+86) 5226 0067
www.gys-china.com.cn
E-mail : contact@gys-china.com.cn

Bao Zhi Long Electrical Equipment (JV GYS)

Room: 203C
Building: N°1
N°518 Shen Wang Road
Minhang District Shanghai
China
Tel1 : (+86) 52217650
Tel2 : (+86) 52217651
Tel3 : (+86) 52217652
Fax : (+86) 52217653
www.bzl-china.com
E-mail : mz@bzl-china.com

www.gys.fr



Distributed by

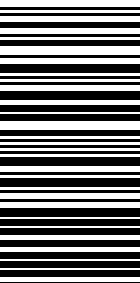

Document non contractuel. GYS se réserve le droit de modifier sans préavis les spécifications de ses appareils - Document not contractual.
GYS reserves the right to modify the specifications of the machines without prior notice. Irrtümer und Änderungen vorbehalten.